

Community Policing in Chicago, Years Eight and Nine
An Evaluation of Chicago's Alternative Policing Strategy
and Information Technology Initiative

Prepared by
The Chicago Community Policing Evaluation Consortium

Wesley G. Skogan
Lynn Steiner
Susan M. Hartnett
Jill DuBois
Jason Bennis

Brandon Rottinghaus
So Young Kim
Kimmy Van
Dennis P. Rosenbaum

Jonathan Anfinen
Lisa Graziano
Ricky Hazelwood
Almas Hussain
Kayla Johnson
Katie Kaminski
Tom Kelly
Jonathan Parker

Sarah Rosenbaum
Betty Ruiz
Diana Ruiz
Rosie Ruiz
Cody Stephens
Negar Tekeei
Alice Virgil
Sheri Wong

The Chicago Community Policing Evaluation Consortium is coordinated by the Institute for Policy Research, Northwestern University. It also includes the University of Illinois-Chicago. It is supported by grants from the Illinois Criminal Justice Information Authority.

January 2003

This project was supported by Grant #00-DB-MU-0017, awarded to the Illinois Criminal Justice Information Authority by the Bureau of Justice Assistance, Office of Justice Programs, U.S. Department of Justice. The Assistant Attorney General Office of Justice Programs, coordinated the activities of the following program office and bureaus: Bureau of Justice Assistance, Bureau of Justice Statistics, National Institute of Justice, Office of Juvenile Justice and Delinquency Prevention, and the Office for Victims of Crime. Points of view or opinions contained within this document are those of the authors and do not necessarily represent the official position or policies of the Illinois Criminal Justice Information Authority or the U.S. Department of Justice.

Printed by authority of the State of Illinois, January 2003
Printing order #03-174
200 copies

Contents

Executive Summary	i
Introduction	1
Trends in Crime	3
Race and Trends in Crime	5
How Did Chicago Do?	9
Trends in Neighborhood Decay and Disorder	11
Physical Decay	11
Social Disorder	18
The Police and the Public	23
Measuring Public Confidence in the Police	24
Race and Trends in Public Confidence	27
Involvement in Beat Community Meetings	29
Trends in Beat Community Meeting Participation	30
What Happens at Beat Community Meetings	34
Model Beat Community Meetings	42
Representing the Community	45
Solving Neighborhood Problems	49
The Problem-Solving Study	50
Measuring Success in Problem Solving	56
Management Accountability	64
The Accountability Process	66
Accountability as a Change Strategy	79
Strengthening Community Policing through Information Technology	90
Information Technology and the Police	90
Origins of CLEAR	92
Description of CLEAR	93
Applications Under Development	99
Automated Incident Reporting	99
Automated Arrest System Phase II	105
Data Warehouse	106
Digital Mug Shot	109
eTrack	114
Gang Module	119
Crime Mapping	121
Juvenile Arrest	124
Organized Crime System	128
Personnel Suite	129
Traffic Crash Report Routing System	133
Adjunct Projects	136
Hyper Text Markup Language (HTML) Conversion	136
Integration of Criminal Justice Information Systems	136
National Incident-Based Record System (NIBRS)	141
Technical Management System	145
Police Employee Attitudes and Use of Technology	146
First Findings	147
Future CLEAR Applications	148
Community Interest and Readiness for Involvement	149
CLEAR in the Coming Year	158

Figures

Figure 1	Trends in Recorded Crime, 1991-2000.....	4
Figure 2	Race and Trends in Violent Crime, 1991-2001.....	6
Figure 3	Race and Trends in Property Crime, 1991-2001.....	8
Figure 4	Chicago and National Trends in Crime, 1991-2001.....	9
Figure 5	Trends in Physical Decay, 1994-2001.....	12
Figure 6	Race and Trends in Physical Decay, 1994-2001.....	17
Figure 7	Trends in Social Disorder, 1994-2001.....	19
Figure 8	Race and Trends in Social Disorder, 1994-2001.....	22
Figure 9	Trends in Confidence in the Police, 1993-2001.....	26
Figure 10	Race and Trends in Confidence in the Police, 1993-2001.....	27
Figure 11	Trends in Beat Community Meeting Attendance, 1993-2002.....	31
Figure 12	Factors Associated With Beat Community Meeting Attendance.....	33
Figure 13	Neighborhood Representation at Beat Community Meetings.....	47
Figure 14	Problem-Solving Study Sample.....	50
Figure 15	Time Series Analysis Example.....	61
Figure 16	Strategic Operational Plan Form.....	69
Figure 17	District Accountability Session Presentations.....	74
Figure 18	Headquarters Session Crime Map.....	76
Figure 19	CLEAR Module/Project Status	96
Figure 20	Tuition Reimbursement Process Flow.....	98
Figure 21	Proposed AIRA Message Switching System.....	101
Figure 22	Data Warehouse Arrest Query Screen.....	107
Figure 23	Digital Mug Shot.....	109
Figure 24	Inventory Record Printout.....	115
Figure 25	Citizen ICAM Report.....	122
Figure 26	Personnel Suite Overview.....	129
Figure 27	Criminal Justice Information Sharing.....	137
Figure 28	Pilot-Test Agencies Menu.....	140
Figure 29	Race, Age, Education and Patterns of Internet Access.....	153

Tables

Table 1	Beat Community Meeting Participant Activism.....	41
Table 2	Components of a Model Meeting.....	43
Table 3	Police and Resident Problem-Solving Strategies, by Type of Problem.....	53
Table 4	Police and Resident Problem-Solving Activity, by Type of Problem.....	55
Table 5	Survey Measures of Problem-Solving Success, by Type of Problem.....	58
Table 6	Analyses of Recorded Crime Trends, by Type of Problem.....	62
Table 7	Problem-Solving Strategies and Outcomes, by Type of Problem.....	63

Executive Summary

This is the seventh report examining Chicago's community policing program. CAPS (for "Chicago Alternative Policing Strategy") began in April 1993, when an experimental program was inaugurated in five police districts. It was field-tested during the ensuing 18 months and then expanded to encompass the entire city. This report presents an overview of evaluation efforts since the release of our last report in November 2000.

Trends in crime. The first major section of this report examines trends in crime. Since 1991 there has been a steady decline in virtually every crime category. The largest percentage decline has been in robbery, which dropped by 58 percent between 1991 and 2001. Robberies with a gun went down by 62 percent, while those involving some other weapon (or none at all) went down by less – 55 percent. Serious assault and battery declined by 40 percent. Gun-related assaults went down a bit faster, as did assaults in domestic situations. On the other hand, gang-related assault did not decline at all. In the property crime category, motor vehicle theft was down by 42 percent. Burglary, which typically involves break-ins of businesses, homes or garages, went down 50 percent, and simple property thefts declined 26 percent over the same period.

Since 1991, crime has declined in almost all areas of the city, but it has declined most dramatically in African-American communities. Crime rates generally declined the least in predominately white areas, where they were not very high at the outset. By the beginning of the 21st century, Chicago was a substantially safer place than it was 11 years before, and residents of African-American neighborhoods have seen much of the improvement. Compared to 1991, 2001 saw almost 300 fewer people murdered in African-American areas of the city, and 1,100 fewer raped. Gun crimes there dropped by 17,400 incidents, and 17,675 fewer people were robbed in predominately African-American beats in 2001.

The exception to all of this good news is the murder rate. Chicago's homicide rate declined more slowly than it did for the nation as a whole: the local murder rate dropped by 31 percent, while the national rate dropped by 41 percent. The year 2001 also saw an actual increase in the city's murder total, from 631 to 666 cases. Over time, the ability of Chicago police to solve the murders that do occur has declined as well.

Trends in neighborhood problems. CAPS involves problem solving on a broad scale, focusing on a wide range of neighborhood concerns in addition to crime. These include both physical decay (including abandoned buildings, abandoned cars, loose trash and graffiti) and social disorder (public drinking, loitering and disruption in schools). The evaluation has tracked concern about these problems using regular surveys of city residents. They reveal that between 1994 and 2001, many residents perceived no particular improvements in the physical condition of the city's neighborhoods. Only concern about graffiti, which was the special focus of several new city initiatives, showed a substantial decline. In the social disorder category, only concern about loitering dropped in any substantial way.

However, the surveys also revealed dramatic variations in Chicago residents' views of their neighborhoods. The most important factor was race. From the point of view of white residents, conditions stayed about the same during the course of the 1990s. They reported few serious problems in 1994, when the surveys began, and somewhat fewer at the end. On the other hand, by most measures, conditions improved considerably among African-Americans. They reported less concern about physical decay and most forms of social disorder over time. Latinos at best held their ground during the course of the 1990s, and by many measures things actually took a turn for the worse in the Latino community. Especially for Spanish-speakers, levels of social disorder and physical decay appeared substantially higher in 2001 than in 1994. The success of this aspect of CAPS depended on who you were and where you lived.

Public views of the police. The next section of the report uses the same surveys to describe trends in the reported quality of police service in the city. Our surveys monitored the views of residents concerning police effectiveness, community outreach and service delivery. Before CAPS was launched, a majority of Chicagoans did not have a very positive view of the police. Less than 40 percent thought the police were responsive to community concerns, and fewer still thought they were doing a good job at preventing crime and helping victims. They were seen as fairly polite and helpful, but not as very effective.

Public opinion improved significantly during the course of the 1990s. By 2001, more than 70 percent thought police were being polite and helpful, and nearly 55 percent thought they were responsive to public concerns. Almost half of all Chicagoans gave them a satisfactory rating for preventing crime, keeping order and helping victims. Moreover, these improvements could be seen among all major population groups. Whites, African-Americans and Latinos all gave police higher ratings than they did prior to CAPS being launched. Among African-Americans and Latinos, perceptions of the police changed most on the responsiveness dimension, improving by about 20 percentage points. However, our surveys indicate that there is still ample room for improvement. After eight years of community policing, a little less than half the public thought that police were doing a good job at preventing crime, helping victims and maintaining order, and only a few more thought they were doing a good job responding to community concerns. "Helping victims" was the lowest-rated form of service included in the surveys; by this measure, police were not seen as responding to the needs of some of their most important customers. The large gap that existed between the races in 1993 persisted through 2001. Our summary of trends in Chicago is that "the glass" representing the views of city residents about police went from being "less than half full" to "a little more than half full."

Citizen involvement. Chicago's community policing initiative features important roles for the public. A section of the report examines trends in beat meeting attendance and the results of a study of meetings all over the city. Attendance at the meetings has remained stable, averaging about 6,000 persons per month. Chicagoans attended beat community meetings about 59,000 times during 1995. The figure for 1997 was almost 65,000, and in 1999, 67,000 persons showed up. The figure for 2001 was 66,600. Over the 90-month period between January 1995 and June 2002, more than 488,000 Chicagoans attended more than 21,000 beat meetings.

Beat meeting attendance rates are often highest in places that can benefit the most from them. Rates are highest in the city's predominately African-American beats and lowest – once population is taken into account – in predominately white areas. In general, attendance rates are higher in lower-income areas, where people do not have much education. They are also high in areas where other institutions, including schools and the health care system, have failed to serve residents very well. Participation is also highest in high-crime areas, and concern about crime is an important factor motivating people to attend the meetings.

Residents who attend the meetings are often involved in other CAPS-related activities. A survey of attendees found that 12 percent reported participating in “smoke outs, CAPS picnics or barbeques.” Participation in neighborhood watches and patrols was surprisingly popular, reported by 21 percent of those attending. Court advocacy is an official CAPS project that is sponsored by the district's advisory committees, and 11 percent of those attending beat meetings reported some involvement in that effort. “Vote Dry” is the common label for efforts to close down troublesome liquor establishments in the city using a referendum process, and 12 percent indicated they had been involved in that or some other liquor control project. Beat activism is more common in lower-income, African-American areas of the city; where health problems and low school test scores are also an issue; and in areas with high rates of violent crime.

There is a design for conducting beat meetings as well as for what is supposed to happen there: they are to be forum for sharing information, identifying problems and making action plans. Both police and citizens are expected to take responsibility for problem-solving projects, and beat meetings provide a venue for everyone to review their progress and assess how well they are doing. A 2002 study examined how closely activities at beat meetings reflected the design by calculating a “model meeting” score for each. Of the 10 components of a model meeting, the average meeting scored 6.2. While better than the average in our 1998 study, this leaves clear room for improvement.

Problem solving. The next part of the report analyzes one of the core elements of CAPS – problem solving. It is based on a field study of problem solving in 68 beats, interviews with beat officers and neighborhood activists, and a statistical analysis of trends in recorded crime and 911 calls. Our analysis of these sites found that the most common police problem-solving strategy was high-visibility patrol, followed by increased arrests, then aggressive stops (including intensive traffic enforcement; warrant, name and license checks; and field interrogations). Overall, these tactics were employed at about 70 percent of the priority problem sites. Nontraditional policing strategies were also described fairly often, particularly for property crime. It was very common to hear about prevention awareness programs run by police officers, especially for property crimes such as burglary and theft from autos. Some of the roll calls that are held at the start of each shift were conducted outdoors, in gang and drug areas, and police in areas with drug problems were described as talking with residents at beat meetings and using code enforcement as well as other tools to attack the problem.

Residents were most frequently involved in block club organizing as well as community marches and patrols. They also ran educational campaigns and crime prevention projects, and

worked with businesses. Neighborhood or park patrols, programs with businesses, educational programs and community rallies were the most frequently held community efforts targeting social disorder. City agencies were also often involved in problem solving. The Department of Streets and Sanitation and the Forestry Department predominated, for the bulk of the services described involved street lighting projects, clean-ups, trimming trees and bushes, car tows, graffiti removal and sidewalk repairs. The city's CAPS Implementation Office was involved at almost 80 percent of the problem sites.

The effectiveness of these efforts was assessed in two ways. First, police, residents and our observers rated the extent of the improvement in the study areas. Their ratings formed two broad evaluative clusters, one focused on changes in the frequency and impact of problems and the other on changes in resident involvement in problem solving and their satisfaction with police efforts. In addition, a statistical analysis of crime and 911 call data assessed the extent of changes in the study beats as compared to a matched set of comparison areas. Police efforts were most successful against property crime and least successful in countering social disorder. Community strategies and nontraditional police efforts worked best against drug problems, and traditional and nontraditional policing strategies were generally most effective when tackling property crime and social disorder.

Management accountability. The report also describes the department's new accountability process. This management initiative is designed to focus the department's resources on resolving chronic crime and disorder problems; it is Chicago's version of New York's famous "CompStat." In Chicago's plan, the 25 police districts are responsible for identifying local priorities, planning strategies to address them and then executing their plans effectively. New information systems being developed by the department promise to deliver expanded and more timely information to assist district management teams in making their plans and headquarters in evaluating how well they are doing. This is widely known as "intelligence-driven policing."

The management accountability process has accomplished a great deal. It has enabled the department to set specific, measurable goals for which mid-level managers can be held accountable, and has begun to foster a "culture of accountability" in the organization. Commanders have developed a more intimate knowledge of their districts, using the available information technology to assist them in doing so. Managers are expected to more effectively use resources that are already in their hands. This includes taking measures to curb complaints about officer misconduct, decrease the number of unanswered 911 dispatches, make sure officers are spending the right amount of time on assignments and keep overtime expenditures under control. The process also forces managers to focus on priority problems, targeting specifically where limited resources will have the greatest impact. More of the department's special units have gotten involved in solving district problems. Special units include detectives; narcotics investigators; a special operations section that provides roving bands of tactical officers; the public housing unit; the youth division; and the school safety division. The accountability process tries to break down the barriers between the department's divisions to foster communication and collaboration among them at the operational level. The accountability

process has also led the CAPS Implementation Office to organize more activities that support the districts' priorities.

Information technology. The final section of the report presents our first analysis of a new information technology initiative by the police department. Dubbed CLEAR (for Citizen and Law Enforcement Analysis and Reporting), this enterprise system is intended to “take CAPS to the next level,” as the superintendent puts it, by positively affecting crime and disorder through management accountability. CLEAR will affect many department functions and promises to increase the efficiency and effectiveness of policing in Chicago.

Almost 20 major information technology projects are currently underway. Some are aimed at enhancing the managerial capacity of the organization. These are intended to promote effective resource allocation, enhance officer accountability, monitor personnel problems, assist tactical and strategic planning, and ensure fiscal accountability. The most work has been done on automating incident reporting, tracking the flow of evidence, digitizing mug shots, mapping crime and modernizing the department's personnel system. Efforts are underway to expand the range of data collected on crime incidents to facilitate crime analysis and contribute to a growing national database on criminal offenses. Other projects promise to coordinate the work of regional law enforcement agencies, prosecutors, the court system and the state corrections department. State and suburban jurisdictions are already integrating their data into the department's data warehouse. The aim is to increase information sharing, eliminate bottlenecks in the criminal justice system, and provide a comprehensive view of crime and punishment in Illinois. There is also interest in developing systems to strengthen the department's problem-solving capacity, conduct community needs assessments and facilitate information sharing with the community.

While our evaluation of Chicago's efforts has just begun, other jurisdictions have reported difficulties in successfully completing comprehensive information technology projects. The list of obstacles is long. Sometimes too much responsibility is lodged with a few isolated staff members, often civilians with limited knowledge of officers' needs. Agencies consistently underestimate the human factors involved in launching these new initiatives. Use of new technologies has sometimes been limited because of inadequate training and the perception that the technologies made officers' work days more difficult rather than easier and more effective; officers must believe that adopting change will benefit them personally and make their jobs easier or more interesting. But software systems can prove so cumbersome to use that only the most motivated continue to try. Too often these projects collapse due to inadequate planning and insufficient funding.

The planning and early development stages of CLEAR were designed with these problems in mind. Each application within CLEAR undergoes a multi-stage development process involving cooperation between police officers and technical developers, pilot testing in the field, and training for the eventual users of the systems. Applications are implemented only after focus groups have offered feedback about their usefulness; internal marketing has taken place to elicit user interest and buy-in; and field testing has determined that the application will work properly. The project has considerable funding and a dedicated and talented team of system

developers. However, realization of each application requires a great deal of time and effort, and many applications are dependent upon one another. Continuing issues are protecting the data to be shared from misuse and protecting individual privacy rights. It is still not clear how the department will involve the community in a meaningful and mutually beneficial partnership; this will be forged when the community is not simply an information provider but also a recipient of useful information and an independent monitor of the quality of service that is being rendered.

The report concludes with a look ahead to our evaluation activities in the coming year.

Community Policing in Chicago, Years Eight and Nine

Introduction

This is the seventh in a series of reports examining Chicago's community policing program. CAPS (for "Chicago Alternative Policing Strategy") began in April 1993, when an experimental program was inaugurated in five police districts. Many operational aspects of CAPS were field-tested during the following 18 months, before it began to expand to encompass the remainder of the city. By then, civilian District Advisory Committees had been nominated in all 25 districts. A coordinated system for delivering city services in response to police service requests was phased in and became operational throughout the city by July 1994. During the fall of 1994 the remaining 20 police districts divided their officers into rapid response units and beat teams. Beat team officers are to spend most of their time responding to calls and working on prevention projects in their assigned area, and dispatching procedures have been fine-tuned to ensure that they stay there. Sergeants and mid-level managers went through several training programs, and between January and May 1995, virtually all uniformed officers completed three days of problem-solving training. Civilian administrative managers were assigned to each of the districts. Beat community meetings were held citywide by spring of 1995.

A department general order released on April 29, 1996, codified many organizational features of the program. It created a new planning process that begins with the formal identification of beat problems and the resources required to attack them, and culminates in the formulation of district and area plans that respond to those needs. Beat community meetings provide community input in setting these priorities. Starting in autumn 1995, organizing and problem-solving training sessions for the general public were being conducted across the city by teams of civilians and police officers. The role of sergeants who supervise beat teams was clarified, and special training sessions were held for them. The Strategic Inspections Task Force was formed in November 1996 to coordinate the efforts of police and other city agencies against gang and drug houses, as well as negligent landlords. During 1996, data terminals were installed in all patrol cars. The city's new Office of Emergency Communication ended its first full year of operation, a period that saw significant improvements in emergency dispatching and the delivery of management data that increase the analytic capacity of the police department.

During 1996 and 1997 the city also expanded its staff of community outreach workers charged with assisting beat and district projects and sustaining participation in beat community meetings. More staff members were brought on to support a new emphasis on housing issues and the Court Advocacy program, which enlists the help of community members to support prosecution efforts for local crime and disorder problems. Beginning in 1997, the department began to tailor its rookie training curriculum to CAPS. Finally, during 1996 and 1997 the city mounted a substantial civic education effort through the media. Television and radio programs, billboards, videos, brochures, mailings, festival booths, and district and citywide rallies were targeted at promoting awareness of CAPS and involvement in its activities. Block club conventions, citywide and regional neighborhood assemblies, CAPS rallies and a national conference on community policing have showcased Chicago's efforts.

More recently, city attorneys have been assigned to selected district stations to work directly with officers on drug and gang problems in their beats. In a similar vein, the Cook County state's attorney has begun a community prosecutions program in which attorneys working out of three neighborhood offices intercede in a range of crime cases. A new city department has been created that consolidates many kinds of CAPS-related quality-of-life cases for administrative adjudication, removing them from the courts. In 2000, a new unit was created within the police department that was charged with revitalizing key components of the city's community policing effort. The Office of Management Accountability (OMA) is responsible for ensuring that the department remains focused on its core missions, particularly when it comes to mobilizing resources required to address chronic crime and disorder problems. In 2001, the department embarked on the development of a state-of-the-art integrated criminal justice system known as Citizen and Law Enforcement Analysis and Reporting (CLEAR). The CPD intends to support CAPS by deploying new and improved systems of accountability that range from early warning personnel systems to automated case reporting to tracking criminal evidence and, eventually, to predictive analysis. CLEAR is forging linkages with other criminal justice agencies and cultivating new ways to integrate policing with the business and community sectors of the population.

This report presents an overview of our evaluation efforts since the release of the last report in November of 2000. At the end there is a list of other CAPS reports, articles and books. The first major section of this report examines trends in crime and neighborhood problems. It is apparent from the newspapers that crime has declined in many of the nation's cities, and this section describes what has happened in Chicago. But CAPS involves problem solving on a much broader scale, focusing on a wide range of neighborhood concerns. These have been tracked by regular surveys of city residents, and this section also examines trends in neighborhood conditions from the viewpoint of the general public. The next section of the report uses the same surveys to describe trends in the quality of police service in the city. Our surveys monitor the views of residents concerning police effectiveness, community outreach and service delivery, and over time these measures of performance have improved significantly.

The third section of the report examines citizen involvement in CAPS. Chicago's community policing initiative features important roles for the public, and this section examines the extent of citizen awareness of the program and participation in it. It describes trends in beat community meeting attendance and the results of an extensive study of meetings all over the city. This includes an analysis of the representativeness of the city's population at beat community meetings. The next part of the report analyzes one of the core elements of CAPS – problem solving. It is based on a field study of problem solving in 68 beats, interviews with beat officers and neighborhood activists, and a statistical analysis of trends in recorded crime and 911 calls. The fifth section describes the police department's accountability process. This management initiative is designed to focus the department's resources on resolving chronic crime and disorder problems; it is Chicago's version of New York's famous "CompStat." The final part of the report presents our first analysis of a new information technology initiative by the police department. Dubbed CLEAR, its applications will affect many department functions and promise to increase the efficiency and effectiveness of many police procedures.

Trends in Crime

Any decline in crime is welcome news, and the magnitude of the decline that has occurred in American cities during the past decade has also been unexpected news. Researchers and practitioners have puzzled over this pattern and argued about where credit should be given. Some point to demography and the economy, others to the waning popularity of crack cocaine, a few to the effectiveness of incarceration and many to smarter policing. Chicago was no exception to the nationwide trend. Many categories of crime peaked in 1991 and then declined sharply. The rate of decline in Chicago has lagged that of some cities, but is ahead of others. As elsewhere, some categories of crime have evidenced an across-the-board retreat, while others have gone down only in selected areas. And in Chicago, like many cities, the decline began while community policing was still on the drawing board.

Figure 1 depicts trends in Chicago for many common categories of crime. It excludes only high-volume property thefts and low-volume arson, which were difficult to display on the same chart. Murder and rape, the least frequent of the offenses presented here, are graphed on a separate scale (right side) so their trends are visible. As Figure 1 illustrates, there has been a steady decline in crime since its peak in 1991 in each of these categories.

The largest percentage decline documented in Figure 1 is robbery, which declined by 58 percent in Chicago between 1991 and 2001. Robbery has long been considered a bellwether urban crime, combining theft, risk to life and limb (a gun is often involved), and premeditation and predatory intent. Between 1991 and 2001, robberies with a gun went down by 62 percent, while those involving some other weapon (or none at all) went down by less, 55 percent. Murder, by contrast, was least down over this period, by 28 percent. In fact, during 2001 the number of murders in the city rose a bit, the only increase in a major crime category during this period. Between 1991 and 2001, murders that took place in domestic situations declined by 52 percent, while other kinds of homicide in Chicago were down by only 23 percent. This is in line with rapid declines in domestic homicide nationally, but since at the start of this period there were twice as many nondomestic as domestic homicides, the slower decline in the larger category predominated. During the 1990s, aggravated assault and battery declined by 40 percent. Assault is an extremely heterogeneous and difficult-to-interpret crime category that includes (among other things) domestic violence, gang battles, bar brawls, violence in schools and disputes between neighbors. Within this collection of offenses, gun-related crime went down faster than nongun incidents, assaults in domestic situations went down a bit more than others, and gang-related assault did not go down at all.

In the property crime category, motor vehicle theft was down by 42 percent between 1991 and 2001. This is an offense that is accurately reported by victims and recorded by police, because of the high value of the average loss and the fact that most cars and trucks are insured against theft. Stolen vehicles are also sometimes recovered, another reason to keep accurate

Figure 1
Trends in Recorded Crime, 1991-2000

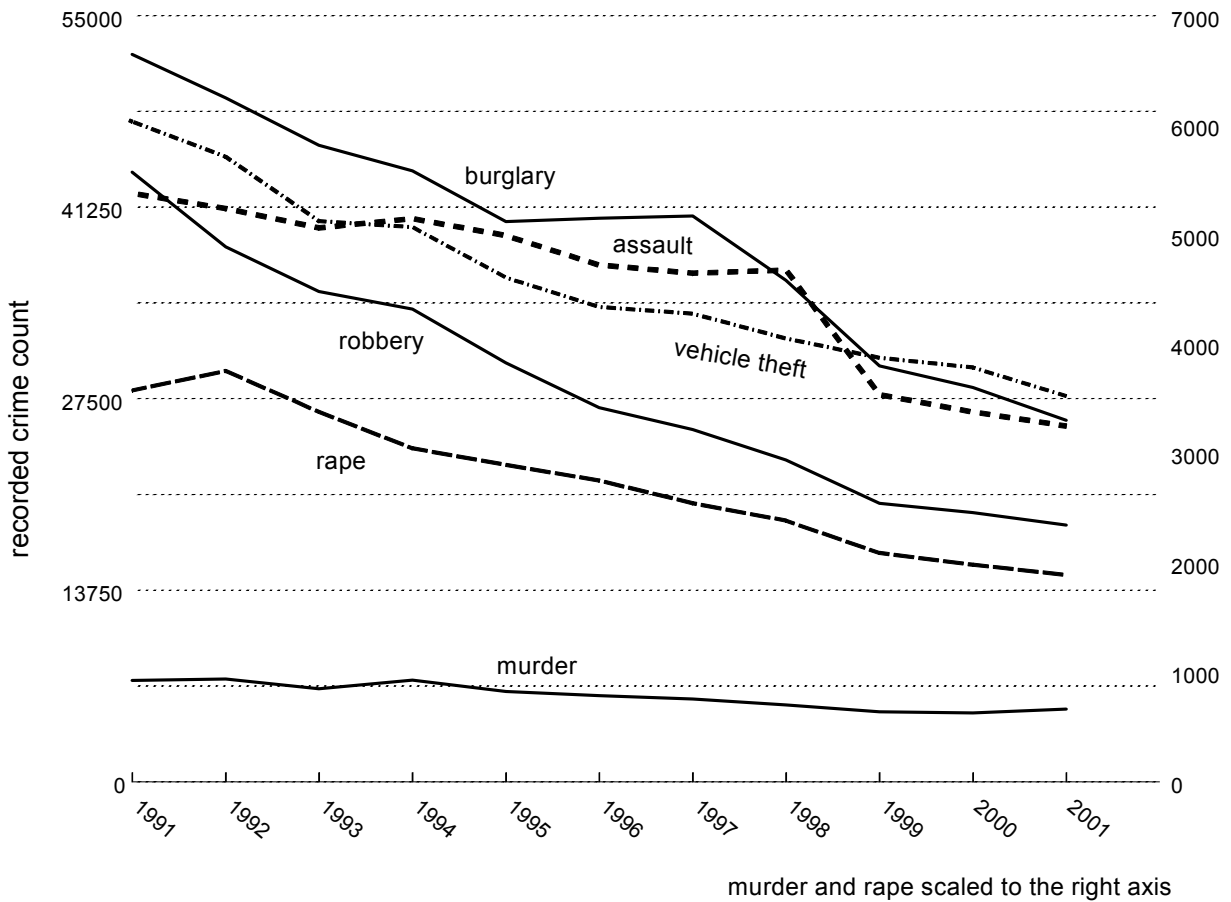

reports. Burglary, which typically involves break-ins of businesses, homes or garages, went down 50 percent. Residential burglary went down less (by 46 percent) than nonresidential offenses, which declined by 60 percent. Simple property thefts (which are not shown in Figure 1) declined 26 percent over the same period.

Chicago became a safer place as a consequence of trends in the 1990s. To illustrate the magnitude of the decline in crime, conditions in 2001 can be compared to a “what if . . .” world in which crime did not decline. For example, between 1991 and 2001 the yearly homicide count declined from 927 to 666, but during the period a total of 8,659 persons were still killed in the city. If the murder count had not declined, but had instead remained at its 1991 level throughout the period, 10,197 people would have died. The crime drop in Chicago saved 1,538 lives, by this

accounting. The consequences of the drop in crime are even more stark in higher-volume offense categories. If the drop had not occurred, there might have been 166,800 more robbery victims, 71,600 more victims of assaultive violence, 141,800 more burglaries and 125,400 more cars stolen. Those are large numbers, and they help illustrate the social and economic significance of what took place in Chicago toward the end of the 20th century.

Race and Trends in Crime

Where did crime decline? Who enjoyed the benefits of the large drop in crime documented in Figure 1? To answer these questions, the city's 270 residential beats were grouped by their racial composition according to the 1990 census. They were divided among 71 predominately white beats, 121 heavily African-American areas, 32 beats of concentrated Latinos residence and 46 diverse areas. Because the city changed its beat boundaries during the early 1990s, crime incident reports supplied by the police data center were individually geocoded to place them in consistent areas. The aggregated groups of beats differed in size, so the analysis reports rates of crime per 100,000 persons living in each area¹.

Figure 2 presents trends for a selection of personal crimes. These include several standard categories of crime described earlier, and two special analytic categories of crime. In most instances, the most notable declines in violence occurred in the highest-crime parts of the city. The trends presented here begin in 1991, the first year that it was practical to geocode city crime data. As Figure 2 documents, crime was down in all or most areas, but it declined most dramatically in African-American communities. Crime rates generally declined the least in predominately white areas, where they were not very high at the outset. However, in percentage terms, even white beats enjoyed significant declines in violent crime during the course of the 1990s.

The large decreases in crime registered by residents of predominately African-American beats are apparent: robbery was down by 62 percent, rape by 46 percent, murder by 38 percent, and assault by 27 percent. Other areas also saw significant percentage declines. For example, robbery in predominately white areas dropped 43 percent, and for Latinos it was 47 percent. At the low end, the 27 percent decline in assault in African-American beats was paralleled by a 22 percent decline in heavily Latino areas and a 13 percent decline in predominately white neighborhoods. In white areas the homicide rate actually ended the period at a higher level than it began, up 0.5 percent. However, it is apparent in Figure 2 that the real Chicago story was the 11-to-1 ratio between homicide rates in African-American and white beats, and that declines in

¹ Crime rate calculations used the estimated population for each aggregated group of beats for each year. These estimates were made by interpolating changes between the 1990 and 2000 census figures for each beat. This helped to account for the fact that some predominately white beats in 1990 lost population by 2000, while many predominately Latino beats gained in population over the same period.

Figure 2
Race and Trends in Violent Crime, 1991-2001

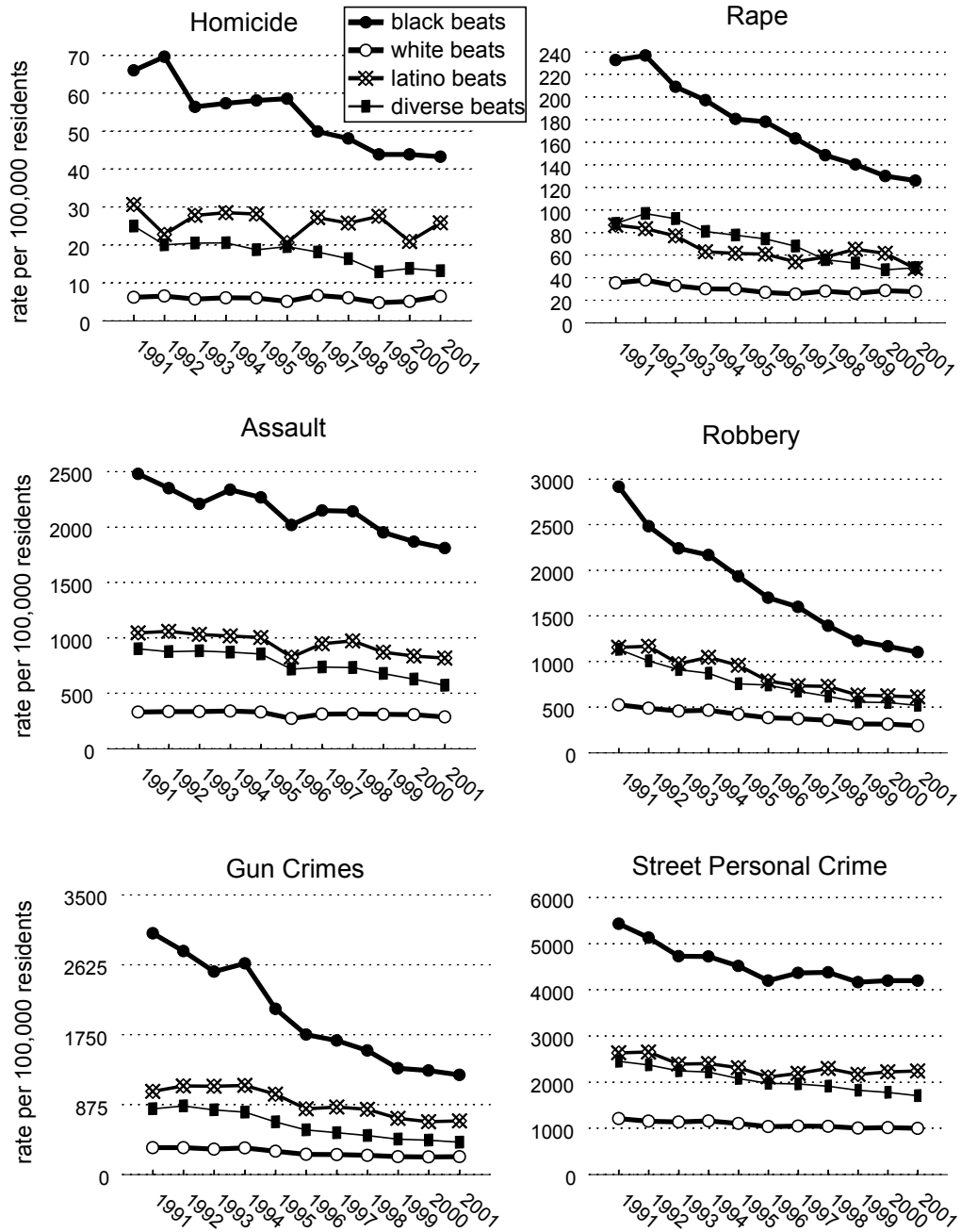

the former – along with declining crime in racially diverse areas – powered the almost 40 percent decline in homicide in Chicago during the 1990s.

Figure 2 also includes a special tabulation of trends in “street crime.” The street personal crime index includes violent offenses that took place on the street or sidewalks, in alleys and parks, in parking lots and driveways, and along the lakefront. Between 1991 and 2001, street personal crime declined by 23 percent in predominately African-American beats. Perhaps more significant was the decline in gun crime there. A gun crime measure was developed by scanning recorded crime incidents between 1991 and 2001 (a total of about 6.9 million computer records) for gun involvement, independent of the type-of-crime classification used by the police. In comparison to other areas, the most distinctive feature of crime in Chicago’s predominately African-American beats is the use of guns. In every crime category, both the gun crime rate and the percentage of crimes that involve guns is highest there. In 1991, for example, 41 percent of all robbery in predominately African-American beats involved a firearm, compared to 34 percent in white areas and 32 percent in predominately Latino beats. Virtually every homicide in African-American areas was by gun. Thus, it was doubly significant that, during the 1990s, the gun crime rate there dropped 59 percent, and the percentage of all personal offenses involving a gun dropped most there as well. Gun crime also declined in heavily Latino areas, by 35 percent.

In short, by the beginning of the 21st century, Chicago was a substantially safer place than it was 11 years before, and residents of African-American neighborhoods had seen much of that improvement. Compared to 1991, 2001 saw almost 300 fewer people murdered in African-American areas of the city, and 1,100 fewer raped. Gun crimes there dropped by 17,400 incidents, and 17,675 fewer people were robbed in predominately African-American beats in 2001.

Figure 3 presents a parallel analysis of trends in property crime in Chicago. Three points are immediately apparent there. First, disparities between property crime rates in the various areas described in Figure 3 are much smaller than they are for violence. If the ratio of black to white area homicide rates was 11-to-1 in 1991, for burglary it was 2-to-1, for property theft 1.6-to-1, and auto theft 1.5-to-1. In Chicago, stealing is – relatively speaking – an equal opportunity offense. The second lesson of Figure 3 is that, like violence, property crime was generally down for all kinds of areas in the city. Thirdly, property crime was down at about the same rate everywhere. There was an equal opportunity benefit in the decline of property crime in Chicago during the 1990s.

Figure 3 presents two burglary trend lines, one for break-ins of all kinds and another for burglaries in which the target was a home or residential garage. In the first example, burglary was down by 52 percent in African-American beats; compared to 1991, almost 12,800 fewer burglaries took place there a decade later. Burglary was also down, by 47 percent, in predominately white beats, and 44 percent (from its 1993 high) in heavily Latino areas. Property theft declined by almost 20 percent in primarily African-American areas, and was down by similar figures in Latino and racially diverse beats; only white areas did not see much

improvement here – just 9 percent. But when property crime only targeting residences is examined, blacks and whites saw about the same 25 percent in crime. (But note the large racial disparity in residential burglary depicted in Figure 3; by this measure, African-Americans are much less safe there.) Property thefts in public places, on the other hand, were down about 15 percent for all groups, and auto theft dropped at about the same pace in all of these areas.

Figure 3
Race and Trends in Property Crime, 1991-2001

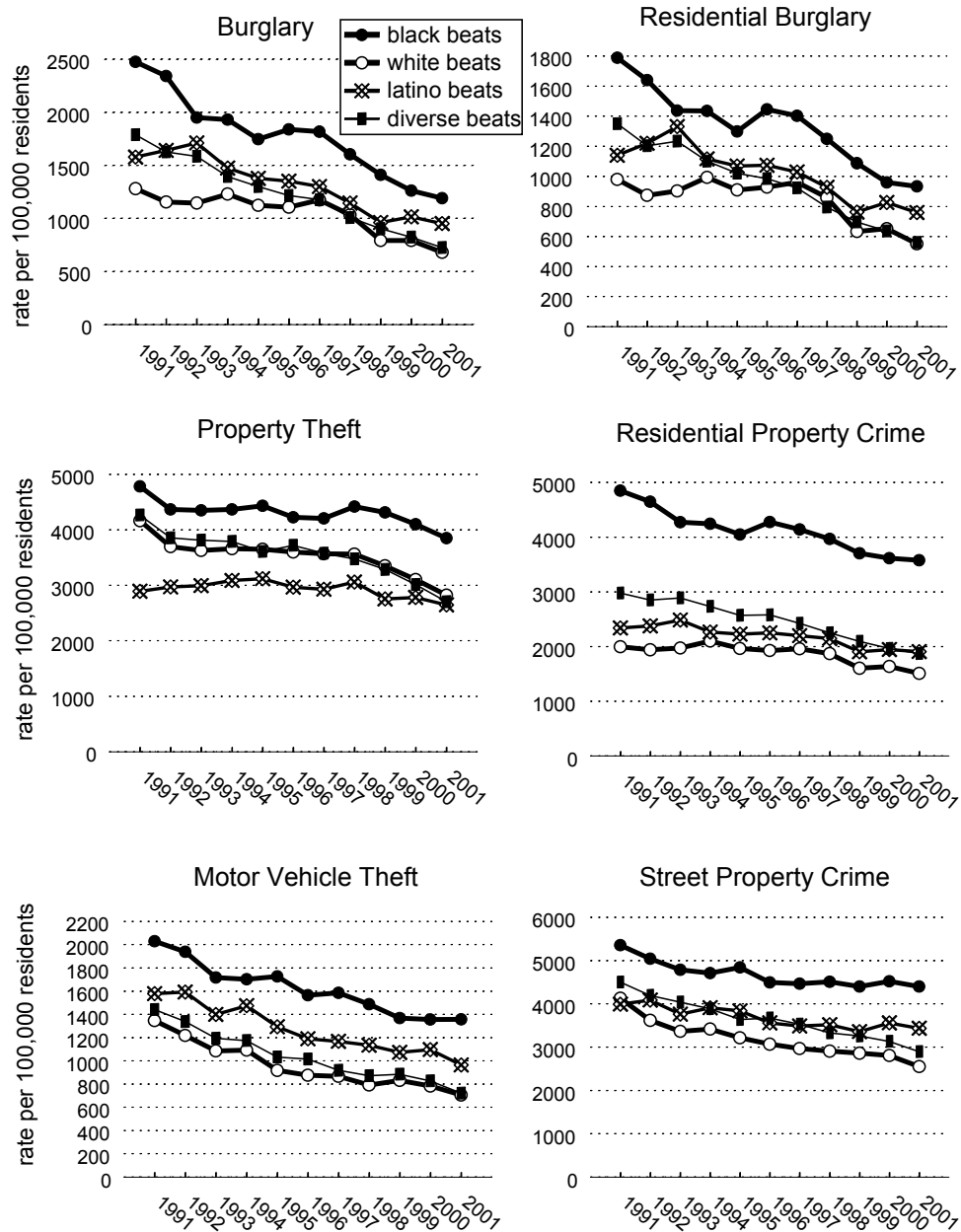

How Did Chicago Do?

While crime declined in Chicago during the entire period discussed here, it did in many other cities as well. The general decline in crime in the United States was one of the most important social phenomena of the 1990s. Between 1991 and 2001, personal crimes reported to the police declined by 25 percent nationwide, and property crime dropped by 20 percent.

Did Chicago do as well as the nation as a whole? To examine this issue, Figure 4 compares city and national crime rate trends for the period 1991-2001. To do so, it standardizes both figures at “100” for 1991 and depicts each subsequent year’s crime rate as a percentage of the 1991 rate. For example, by 2001 the city’s robbery rate had dropped to 40 percent of its 1991 level, while the national rate had only dropped to 56 percent over the same period. This standardization ignores the fact that levels of crime are much higher in big cities than they are for the nation as a whole, in order to make a clearer comparison of trends in crime.

Figure 4
Chicago and National Trends in Crime, 1991-2001

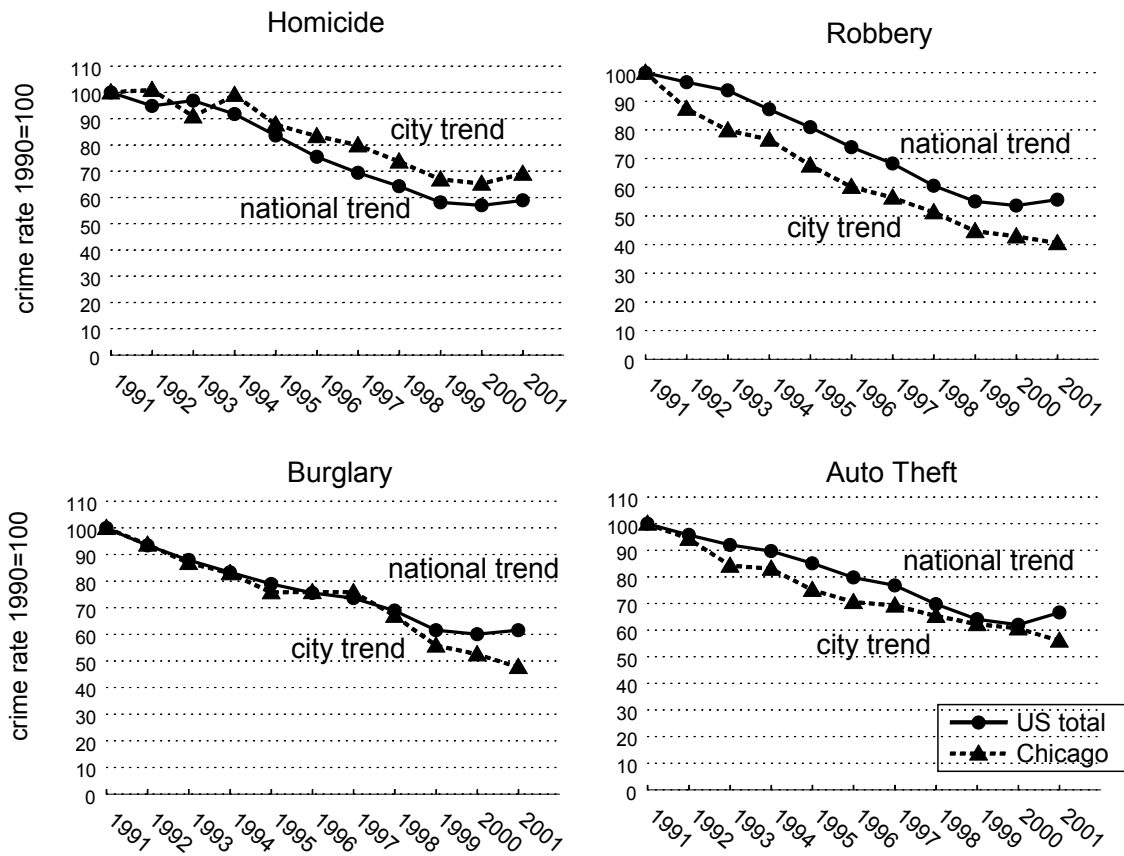

As Figure 4 illustrates, the decline in robbery in Chicago proceeded faster than the national pace. City and national trend lines were virtually identical for burglary until the end of the 1990s, when the national rate of decline slowed noticeably, and in 2001 the national burglary rate increased slightly. By 2001 the national burglary rate stood at 62 percent of its 1991 level, while in Chicago it was 48 percent. Chicago's auto theft rate fell faster than the nation's during much of the 1990s. Differences in the rate of decline narrowed later in the decade, but in 2001 the national auto theft rate spiked upward while Chicago's continued to decline, and the drop in Chicago was 10 percentage points greater than that of the country as a whole.

Murder was a different matter. Chicago's homicide rate declined more slowly than it did for the nation as a whole, and by the first year of the new century the national figure was down by more. Chicago's murder rate had dropped by 31 percent, while the national rate had dropped by 41 percent. Local media concentrated on the difference between the Chicago figure and that of New York City, for although the latter has more than twice Chicago's population, in 2001 it had fewer murders. The year 2001 also saw an actual uptick in the murder total, from 631 to 666 cases. When these trends became apparent in December 2001, the *Chicago Tribune's* headline read, "City to Get a Dubious Title: No. 1 in Murder." Of course, Chicago's homicide rate was far from being the highest in the nation; seven cities faced higher rates when populations were taken into account, but because they were smaller, their total body count was much smaller.

Like many cities, the ability of Chicago's police to solve homicides has also been in decline. In 1966, the Chicago Police Department claimed to have solved 94 percent of them, but the usual figure during the 1960s and early 1970s was in the high 80s. As late as 1986, Chicago claimed to have solved 80 percent of its murders. But then the rate at which police "cleared" homicide went into sharp decline. In 1990, the solution rate was 72 percent, in 1995 it was 62 percent, and it dropped to 50 percent in 1999. In the first year of the new century the clearance rate was 47 percent, exactly half the 1966 figure.

Homicide clearances used to be higher because a large percentage were crimes of passion or fueled by alcohol. They involved offenders who were known or even related to their victims, or they arose out of fights in bars, and they were usually easy to solve. However, much of the nationwide decline in homicide during the course of the 1990s was in these categories. Now drug-related youth violence, gang-related murders and other more calculated killings make up a larger percentage of offenses. The changing character of victims and offenders is signaled by the fact that in 2001, the average murder victim had been arrested 8.3 times in the past decade and the average offender eight times. The changing character of homicide in Chicago is signaled by an increase in the percentage involving a gun: in 1983, 57 percent of murders involved a gun, and in 1993 it was 72 percent. When it is possible to figure out the motive, about half of Chicago's murders now involve gangs and/or the drug business. But compared to the past, a much larger percentage are now classified as "motive unknown," "relationship unknown" and "stranger on stranger" cases, and these can be difficult to solve. In 1972, police reported they could not uncover much about offenders – for example, even their relationship with the victim remained unknown – in 8 percent of homicides. In 1986 that figure was 21 percent; in 1990 it was 29 percent; in 1998 it was 37 percent; and by 2000 it was 42 percent. As the number of

homicides in Chicago declined during the 1990s, a larger percentage of what was left was difficult to solve, at least by the traditional routines of the police department.

Chicago police have made some changes in response. They have become more aggressive about searching for violent offenders wanted on warrants, and they patrol more heavily in areas with concentrated violence. The department's drug enforcement efforts are also more focused on drug-related violence. The department reorganized detective work in a few districts, returning to the old practice of assigning murder investigations to an elite homicide squad rather than parceling them out to detectives with more diverse caseloads. A series of forums chaired by the superintendent of police has led to increased interagency cooperation in tackling violence in one of the city's highest homicide zones. The questions are, will they be able to resolve more of these hard-to-solve cases primarily by applying traditional policing methods more vigorously; and can the homicide pattern that has emerged in Chicago be prevented by evoking this traditional police prevention strategy – deterrence through arrest – when the average offender has already been arrested eight times? Observers will certainly be watching to see the results. A December 2001 *Chicago Tribune* editorial commented, “. . . the way to make the streets safer for everyone isn't to cling only to current strategies. Chicago doesn't have all the answers. Search hard for new ones.”

Trends in Neighborhood Decay and Disorder

Regular surveys conducted for the CAPS evaluation enable us to examine trends in the extent of neighborhood problems over time, beginning in 1994. This was after CAPS was announced and development of the program began in prototype districts, but a year before it expanded to encompass the entire city. The surveys asked about neighborhood conditions using categories that are readily understood by the public, and they included many concerns that are not easily gauged using official statistics. The conditions were the target of problem-solving projects and city service agencies. The surveys, which were conducted in both English and Spanish, were large enough to track changes in the views of major subgroups of residents. This is an important feature of the analyses below, for citywide averages disguised significant differences in the experiences of many Chicagoans.

Physical Decay

Signs of visible neglect, abandonment and deliberate vandalism plague too many of Chicago's neighborhoods. To measure the extent of such problems, respondents were requested to rate a list of them. Responses to four questions were used to assess the extent of neighborhood physical decay:

- Graffiti; that is, writing or painting on walls or buildings.
- Abandoned houses or other empty buildings in your area.
- Vacant lots filled with trash and junk.
- Abandoned cars in the streets and alleys.

Figure 5 summarizes trends in reports of neighborhood decay during the course of the 1990s. It presents the percentage of respondents who thought that physical decay problems rated as either some or a big problem in their neighborhood.

Figure 5
Trends in Physical Decay, 1994-2001

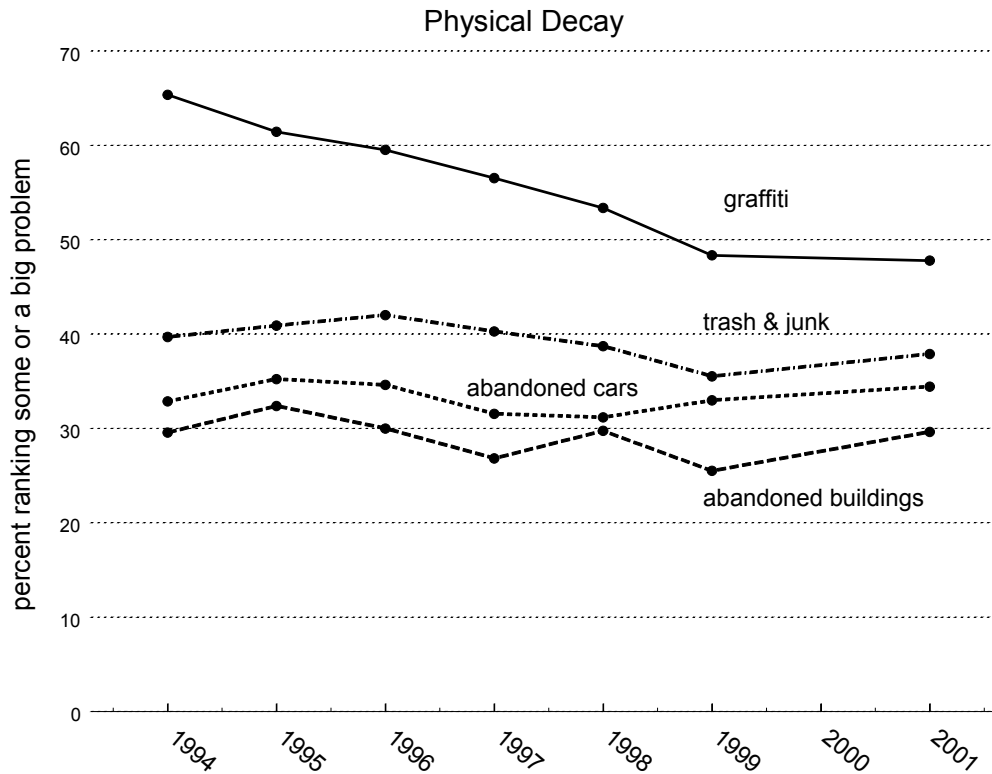

Graffiti. Graffiti presented an important test of the effectiveness of the city service component of CAPS. Graffiti is a common fact of life in many neighborhoods. In 1994 – the first year for which we have survey data – it was the most highly rated problem among Latino residents. Overall, 22 percent of Chicagoans thought graffiti was a big problem in their area; for Latinos the figure was 37 percent; among whites the figure was 17 percent. Chicagoans perceive graffiti as a sign that gangs are moving into their area, or growing more confident of their control of the neighborhood, and discussions pondering the significance of specific instances of graffiti take place at numerous beat community meetings. This dialog was noted by one of our observers attending a beat community meeting in a heavily Latino area on the city’s Near North Side:

A resident said there is a problem with graffiti and drug use in a nearby alley. The officer replied that the person painting the graffiti is an “I-Quest.” He said the graffiti is signed “AOM,” which stands for “another outrageous mind.” He said he has been to the kid’s house and told him that if he sees any more graffiti, he will return. The officer noted that other graffiti is the work of pee-wee Maniac

Latin Disciples. A resident said that residents must paint over graffiti immediately; he said they “cannot let it go.” The officer added that there had been a big problem earlier, because of the anniversary of the death of a gang member. He reported that this graffiti was painted over quickly, and that arrests have been made.

This resident may have been right in his diagnosis about responding to graffiti. One theory is that graffiti is “infectious”; that is, where it appears and is not quickly erased, its visible presence will quickly stimulate still more graffiti. The city’s anti-graffiti program involves strategies besides cleaning it up (including a city ordinance banning the sale of spray paint), but rapid clean-ups are a direct response to the contagion theory. Perhaps the most visible element of the city’s graffiti-elimination program is teams of “Graffiti Blasters” armed with high-pressure soda sprayers, but paint and supplies are also available for community groups bent on removing graffiti on their own. It is also interesting to note the detailed local knowledge that the beat officer had about this specific problem, which is another goal of CAPS.

At a beat community meeting on the West Side, police gave the following advice about using city services to handle graffiti problems:

The beat facilitator told residents to call police if they found graffiti on their garages. He emphasized that the more calls police get, the more resources are allocated to them. A police officer told the residents to call Graffiti Blasters instead, and passed out information about the program. A resident said she called 911 about the graffiti and nothing happened. The female officer explained the process of calling the nonemergency number [311] and filing a report over the phone. The officer passed out waivers to the residents to shorten the process of having the graffiti removed [the waivers give the city permission to use soda blasters and cleaning materials on the resident’s property].

As Figure 5 documents, graffiti problems registered the biggest decline over time. Graffiti was cited as a problem by 65 percent of those interviewed in 1994, and by 48 percent in 2001.

Abandoned buildings. At the other end of the spectrum, building abandonment was the least highly rated decay problem; in 1994, only 30 percent of respondents indicated that it was either some or a big problem in their community. But that number varied greatly by group, with 46 percent of African-Americans, but only 13 percent of whites, reporting that abandoned buildings were a problem in their neighborhood. Building abandonment is a question of economics. It is heavily concentrated in the poorest areas of the city, where it is most difficult to make reasonable rates of return by investing in housing because people do not have much to pay. In poor areas of the city absentee landlords and struggling property owners may be unwilling or unable to maintain their buildings. Though often constructed of brick and stone (a legacy of the building code written following the Great Chicago Fire of 1871), the ravages of time, weather and decades of neglect have left many buildings in poor neighborhoods with crumbling mortar,

peeling paint, rotten framing, broken windows and leaky roofs. If left abandoned long, scavengers pick them clean of items of value, including stained glass, light fixtures, wooden molding, copper electrical wiring and bathroom fixtures. Even aluminum siding will be stripped overnight and exchanged for cash at recycling centers. Squatters may move in, and drug dealers find it easy to set up shop. Eventually many of the remaining hulks are razed as part of the city's aggressive "tear-down" abandonment strategy, because they are no longer habitable and no one can be found to make the investment necessary to return them to use.

There are several city programs for moving against abandoned buildings, but of all the problems here, building issues can be the slowest to be resolved. The rights of property owners must be respected, so they must be involved before their building can be demolished or rehabilitated. Property owners can often be difficult to track down. Illinois allows landlords to hold their property in secret land trusts that enable them to hide their identity from tenants, so police have to use building department records, tax files and the Internet to locate them.

At a beat community meeting our observer noted:

A resident complained about an abandoned building. The beat officer said the building is "terrible, terrible, terrible." He said the owner has never done anything to secure the building from squatters. A resident said that it is illegal for the building to be open. The beat officer replied that he and his partner have put in service requests every week for the past few months. A resident volunteered to call city services. The sergeant told the resident to be sure to mention the police requests.

However, over time there was no change in the extent of resident concern about abandoned buildings. As Figure 5 documents, 30 percent of those interviewed in 1994 thought that building abandonment was some or a big problem in their neighborhood, and in 2001 the figure was again 30 percent.

Trash and junk. In the 1994 survey, 40 percent of Chicagoans rated vacant lots filled with trash and junk as some or a big problem in their area. It was a concern for African-Americans and Latinos, but not for whites (only 5 percent of them reported that trash and junk were a big problem). In two poor African-American beats we studied in detail, many vacant lots were used as makeshift parking lots for cars, trucks and abandoned vehicles. These lots were not only ugly, but they posed a health hazard, as tall weeds, accumulating trash and abandoned vehicles inevitably become nesting spots for rats. Overgrown vacant lots were convenient hiding places for stashes of drugs and weapons that drug dealers did not want to keep on their person. Vacant lots also attracted illegal dumpers, and they provided places for public drinking. Vacant lots pose a risk to communities, and they require maintenance and supervision to prevent them from becoming even greater problems.

Loose trash and junk generally requires a city service response. This discussion took place at a beat community meeting on the Near South Side:

A woman asks the tactical officers to ride down and check the end of the alley where there is a lot of overgrowth, couches and even grills sitting under a tree where people loiter in the abandoned lot. An officer responded that he has been by the lot and he only saw old guys hanging out there, and what first needs to be taken care of is the grass and weeds. The woman continues to complain about the weeds in the lot and how high they are. The officer tells her he will write up a work order and call city services to file a complaint, and that he will speak to her after the meeting to get all the information from her.

Citywide, reports of trash and junk problems also changed scarcely at all over time. As documented in Figure 5, 40 percent of Chicagoans thought this was a problem in 1994, as did 38 percent in 2001.

Abandoned cars. Abandoned cars were cited as a problem by 33 percent of Chicagoans in the 1994 citywide survey. Forty-five percent of Latinos, but only 20 percent of whites, reported it was either some or a big problem, with African-Americans situated in between. Abandoned cars are an easy target for city towing but – like building problems – there are legal niceties that must be observed, unless the vehicle is creating a direct safety hazard. An observer noted this discussion at a beat community meeting on the Near Southeast Side:

A resident asked about an abandoned car. An officer replied that he has reported the car three times, and just reported it as a “hazardous tow,” so it would be considered a priority, but it still has not been towed. The beat facilitator told residents to report abandoned cars when they see them, and give a description. “It is up to you, the community, to clean up the neighborhood.” A resident asked if it would help if citizens called in addition to the police. The officer said the more the better. He said that they can also call about improperly licensed cars, but the police must give a seven-day notice on these.

In another area:

A resident complained of a car that has no license plates and has not moved in several weeks. The officer said that they would take care of it, but that they should not wait for a meeting to complain about this. Several residents confirmed that there is rapid response to towing requests. A resident noted that an abandoned car on her block had been ticketed but that it was still sitting on the street. The CAPS organizer [from the city’s CAPS Implementation Office] informed residents that a car without proper stickers left on the street for seven days is considered abandoned and should be called in to the city.

As Figure 5 illustrates, concern about abandoned cars remained unchanged between 1994 and 2001. Between 1994 and 2001, only one of the four decay problems tracked here – graffiti – showed any noticeable decline at all.

Race and trends in decay. However, citywide trends presented in Figure 5 hide an important part of the story. There was a great deal of variation in trends over time, especially in regard to race. In a nutshell, whites began with little serious concern about physical decay, and things did not change much for them. African-Americans began with many serious problems, but they reported large improvements in neighborhood conditions over time. The city's Latinos, on the other hand, began with serious problems and saw them grow worse over the course of the decade. None of the city's three groups reported experiences that were "average."

Figure 6 illustrates these patterns. It presents separate tabulations by race of the percentage of respondents reporting that physical decay problems constituted a big problem – the most severe rating – in their community. It is also useful to combine responses to these four questions, because responses were consistent every year. Because – based on residents' reports – these conditions tended to occur together, Figure 6 examines a combined index of the extent of physical decay problems, as well as individual problem measures.

As it documents, little changed for the city's whites over this period on three of the four measures. Except regarding graffiti, few whites reported serious concern about neighborhood decay. The high for abandoned car problems was 6 percent in 1996, and in 2001 it was only 5 percent. In no year did more than 3 percent of whites think they had a serious abandoned building problem in their neighborhood. Concern that junk and trash were big problems began at 5 percent, and ended at 7 percent. The exception was graffiti, which was rated some problem or a big problem by 17 percent of whites in 1994. Like other groups, whites reported improvements in graffiti problems over time, dropping to 7 percent by 2001. On the summary index (which charts the percentage of respondents in each group averaging at least half way between "some" and "a big" problem), whites ended up about where they started, but they had relatively little to complain about because these were the problems of the poor.

This provides one explanation for the apparently limited citywide decline registered by most of the problem measures presented in Figure 5. During the 1990s, whites were the second largest racial group in the city, and they had relatively few serious problems needing solving; for white Chicagoans, there was little room for improvement.

A quite different pattern emerged among the city's African-Americans. They rated abandoned cars, abandoned buildings and refuse problems much more highly in the early years of CAPS. They were nine times more likely than whites to think that abandoned buildings were a big neighborhood problem, for example, and five times more likely to give the highest rating to junk and trash problems. Then reports of neighborhood problems by African-Americans declined sharply in seriousness. Serious concern about abandoned buildings dropped by half, from 22 to 11 percent. Concern about refuse-filled lots and graffiti declined by 11 percentage points.

Figure 6
Race and Trends in Physical Decay, 1994-2001

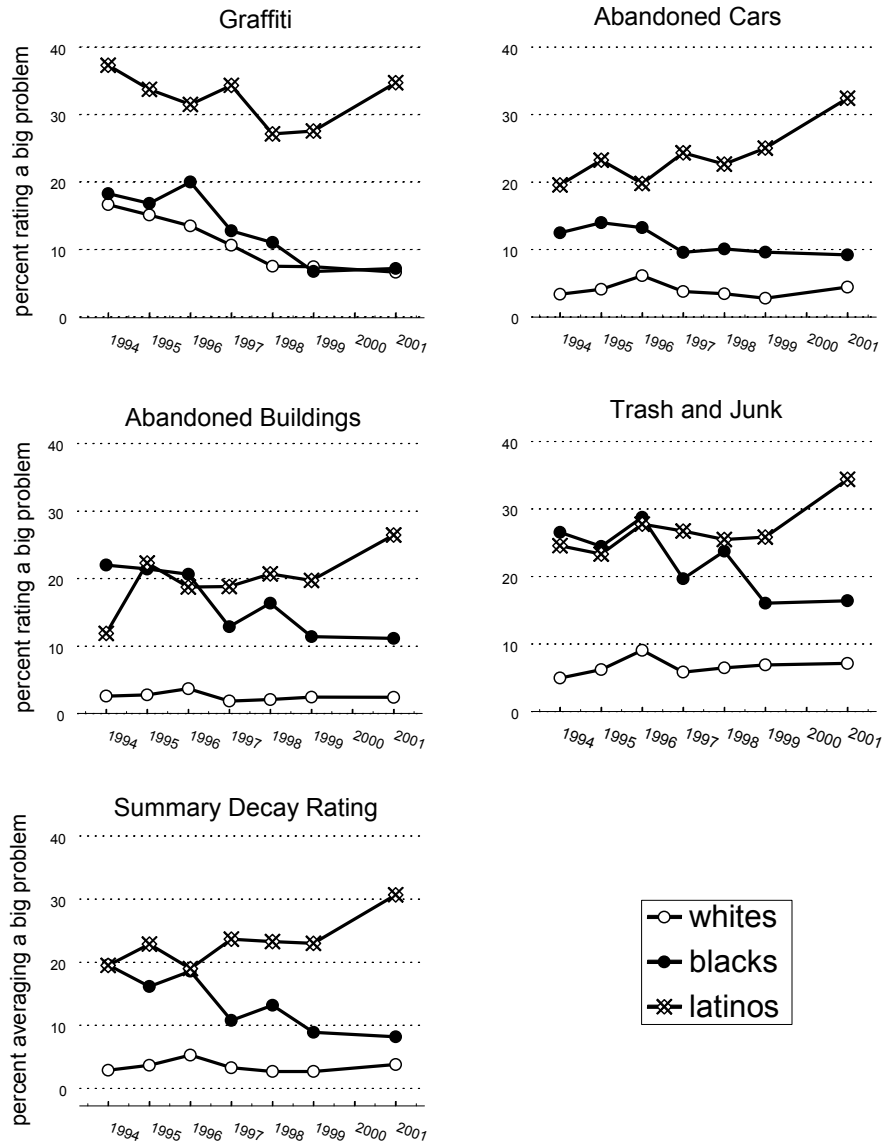

In other words, unlike the city's whites, African-Americans in Chicago had a long way to go. And they did just that, reporting markedly improving conditions during the course of the 1990s. Based on the summary rating presented in Figure 6, decay problems for African-Americans halved between 1994 and 2001.

However, trends reported in Figure 6 do not depict a very hopeful situation for the city's Latinos. In 1995-1996, African-Americans and Latinos reported about the same level of concern

about abandonment and refuse problems, but by 2001 the experiences of the two groups had diverged dramatically. On three measures, Latinos saw relatively little improvement in neighborhood conditions during the 1994-1999 period, and then things grew worse on every dimension. Even the apparent turnaround in serious graffiti problems stabilized during 1998 and 1999, and then reversed itself. By 2001, it was whites and African-Americans who were in the most agreement about improvements in their neighborhoods – although blacks certainly still had a way to go before they could claim parity. Among Latinos, things grew worse. Later in this chapter we will examine these differences in trends in more detail.

Social Disorder

Responses to three survey questions were used to assess the extent of neighborhood social disorder. Unlike the others, questions about the extent of loitering and public drinking were not included until 1995, the year that CAPS became a citywide program. Conditions that were described were:

Public drinking.

Groups of people hanging out on corners or in the streets.

Disruption around schools, that is, youths hanging around making noise, vandalizing or starting fights.

Loitering. The most commonly cited problem on the list of social disorders was loitering, with 59 percent of city residents reporting it as at least some problem in their neighborhood. It probably received this high priority because many Chicagoans associate loitering with a host of related problems, including gang activity, violence, street gambling, public harassment, drug sales, public drinking and other activities. When asked about his neighborhood's biggest problem, one respondent to a neighborhood survey replied: "Drugs. How the guys stand on the corners, you can't even walk down the street because they are selling the drugs. They stand in the middle of the block." Another was concerned because, "The guys are always on the corners saying 'rock,' 'hot' and 'weed'." A third observed that, "Gangs get together on the weekend. They hang out in the streets, they have problems with other gang members and gangs start shooting each other." Another identified his beat's biggest problem as: "Teenagers. No respect. There is no curfew, you hear them cursing, hanging on the corners." Others pointed to problems like "People on the corners in the liquor stores cause fear to other people;" "Guys hanging on the corners all night long;" and, "Younger kids hanging out on the corners and on the next block. It has become a party street because the teenagers hang out on the weekends, and I have called the police because they were so loud around two in the morning."

Loitering became a major political issue in Chicago when the city council instituted an "anti-gang loitering" ordinance that gave police officers the authority to arrest loiterers known to be gang members who did not move along when asked. The ordinance first took effect in 1993, and led to about 10,000 arrests per year. The United States Supreme Court declared the ordinance unconstitutional because of its vagueness, but tens of thousands of Chicago residents signed petitions declaring that their neighborhoods would become safer places if such a law were

in place. Rewritten to follow the Supreme Court’s guidelines and enforced since 2000, Chicago’s gang loitering ordinance weighs most heavily in minority communities: in 1994, while only 11 percent of whites rated loitering a big problem, for African-Americans the comparable figure was 39 percent, and among Latinos it was 32 percent.

Figure 7 summarizes survey reports of the perceived magnitude of social disorder. It presents the percentage of respondents who thought the issues in this cluster rated either some or a big problem in their neighborhood. Between 1995 and 2001, reports of loitering problems declined by only about three percentage points.

Figure 7
Trends in Social Disorder, 1994-2001

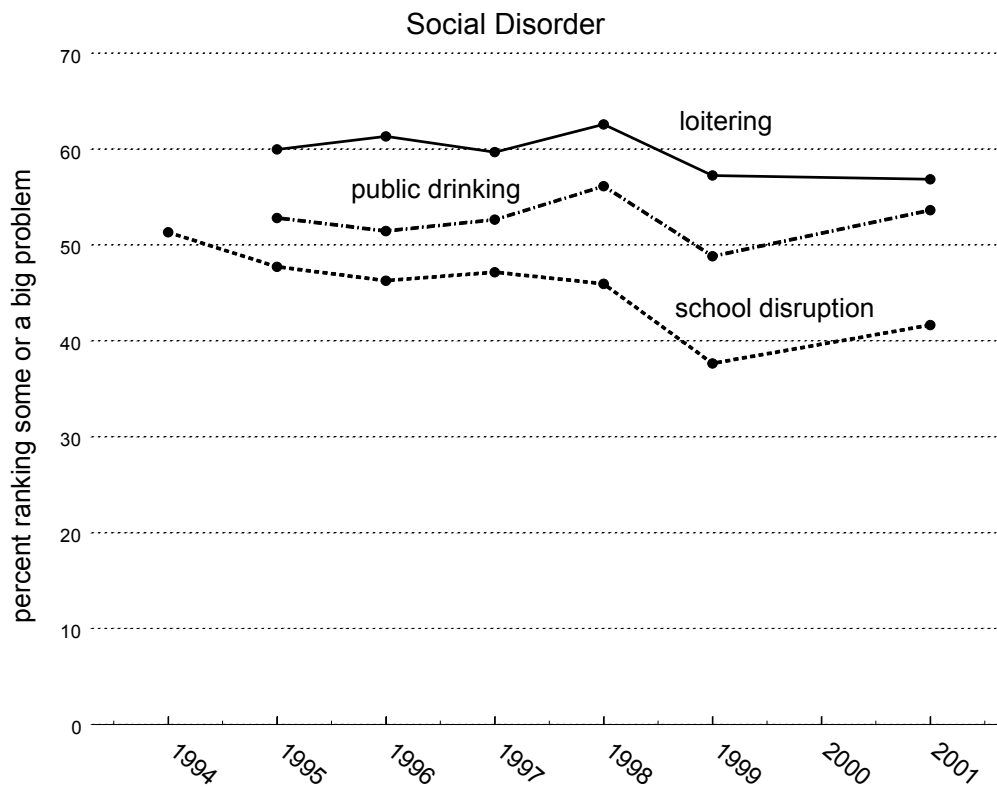

Public drinking. Overall, 16 percent of Chicagoans rated public drinking a big problem in their neighborhood, but among Latinos it was 28 percent; for whites it was only 9 percent. Public drinking was a visible, everyday pastime in some of the poor Latino and African-American beats we studied intensively. Groups of men (and a few women) regularly congregated near liquor stores, usually in vacant lots, or they sat on milk crates and curbs in the alleys and on street corners, never straying far from carry-out liquor outlets. There they sat, passing around bottles wrapped in brown paper, surrounded by overgrown weeds, empty snack food bags, cans

and broken glass bottles. When the police asked them to move, they never went far, moving around the corner or to the other side of the street, just enough to give the illusion of movement. Within minutes, however, the group would gather again. An observer on the city's South Side noted:

Without community pressure, beat officers may not come down hard on the drinkers. One noted, "I know them; they're out here every day. [Several of the drinkers had in fact greeted him by name.] Mostly they are harmless, but they do litter, they urinate in public, and they set a bad example for kids. Adults drinking on the street all day do not make positive role models." In another beat the day-watch officer had less patience. Once, after several unsuccessful attempts to clear away a group of recalcitrant drinkers with his loudspeaker, he drove his squad car onto the sidewalk to disperse them.

In addition, these bands may sometimes be selling drugs. A liquor store owner in the area said he had learned not to call police because he had been threatened in the past. "Once I did call police because they were dealing in front of my store. They broke my car windows and threatened me. I try to be polite and ask these people to move on, but they disrespect me, call me names and threaten me. I don't think it should be my job to get involved. It is too dangerous. That is the police's job." Noting that public drinkers usually congregate around their sources of supply, police and neighborhood activists often look to the city's "Vote Dry" referenda to close them down. According to activists surveyed in 1999, vote dry efforts were underway in 22 of the 25 police districts. An observer noted this presentation at a beat community meeting held on the far South Side:

The neighborhood relations officer then introduced Anthony ___, a member of ___ Church. He explained to residents that members of his church and other residents were working to make the 9th and 34th Wards "dry" and that the only way to get undesirable people off the streets is to close the liquor stores. Last year, 400 church members circulated petitions to get a referendum asking to close liquor establishments placed on a ballot. They were successful in getting some liquor stores closed. The members plan to start circulating petitions in June until August. He told residents that they would be paired up with another person to get signatures and he would pass out flyers later.

However, reports that public drinking was some or a big problem in the area did not decline at all during the 1990s, beginning at 53 percent and ending at 53 percent.

School disruption. Disorder around local schools was identified as a problem by 44 percent of Chicagoans in the 1994 survey. School security issues were described by an officer at a beat community meeting on the Near West Side:

The sergeant brought up problems at _____ School. Because of the warm weather, problems that they normally expected in late March through May were starting now. Girls were getting more involved with gang activity. These elementary school girls were selling marijuana and carrying guns. He wanted to make parents aware and have them look for signs, such as gang-type graffiti on books, and what kids take and bring home in their book bags. Both boys and girls are susceptible.

At another monthly meeting residents of the same beat debated what to do about problems around the same school:

A resident asked what she can do when kids make a lot of noise in the street after 11 p.m. An officer told her to call the police, who can pick the kids up and take them home. Another resident said there is a problem with kids out late on a school playground. She said there are not enough lights on the playground, and that a lot of kids hang out there. An officer asked when the kids are there. She said they are at the school and then go to a house every Thursday through Sunday night. A neighborhood relations officer suggested the residents talk to the principal of the school to see if they can lock the gates after hours to keep people out.

Disruption in and around schools was of particular concern to parents. For example, among Latinos, 34 percent of those we interviewed in 1995 from households with children reported that school security was a big problem; among Latino households without children the comparable figure was only 12 percent. School disruption was a real problem for the city's Latinos because they were the group with the most children. In the 1995 survey, fully 66 percent of Latino households reported having children living at home (this figure peaked in 1998 at 73 percent); in contrast, only 25 percent of white households had children, as did 50 percent of African-American households.

Between 1995 and 2001 the biggest drop in the social disorder category was in reports of the extent of school disruption. As Figure 7 illustrates, the percentage of residents rating school disruption at least some problem in their neighborhood declined from 52 to 42 percent over the period.

But taken as a whole, the city did not see much improvement in the extent of social disorder over time. It may be instructive that the most substantial decline was associated with schools; as we have seen, many positive changes and aggressive security efforts were underway in the city's public schools, in parallel with CAPS. On the other hand, crime in schools was down nationwide during this period. In 2000, the *Chicago Tribune* reported that theft, rape and assault declined by one-third nationally between 1992 and 1999, and total victimization at school was down by 20 percent. The city may have simply been sharing in that general trend.

Race and Trends in Disorder. These overall city figures also disguise the fate of many of the city’s communities. As was the case with physical decay, when groups are examined in detail, it is apparent that some grew better off while others did not. In general, the bulk of the improvements registered in the surveys were reported by African-Americans. On the other hand, Latinos saw few benefits from the program. While white Chicagoans saw some gains, on two of the three measures there was again little room for much improvement.

Figure 8 illustrates the pattern. It presents separate tabulations of the percentage of respondents reporting that problems in the social disorder cluster constituted a “big problem” in their community, and trends in a summary social disorder index. As it documents, little changed in the city’s predominately white neighborhoods over this period. Few whites reported serious neighborhood problems before CAPS was announced. None of the problems in the social disorder cluster was top-rated by more than about 10 percent of whites. Over the next seven years, reports of concern about school disruption declined 50 percent, from 11 to five percentage points. This trend was statistically significant, but those for loitering and public drinking were not; they remained essentially unchanged during the course of the 1990s, albeit at a low level. One explanation for the limited changes registered on most of the citywide social disorder measures is that white Chicagoans had relatively little to complain about.

Figure 8
Race and Trends in Social Disorder, 1994-2001

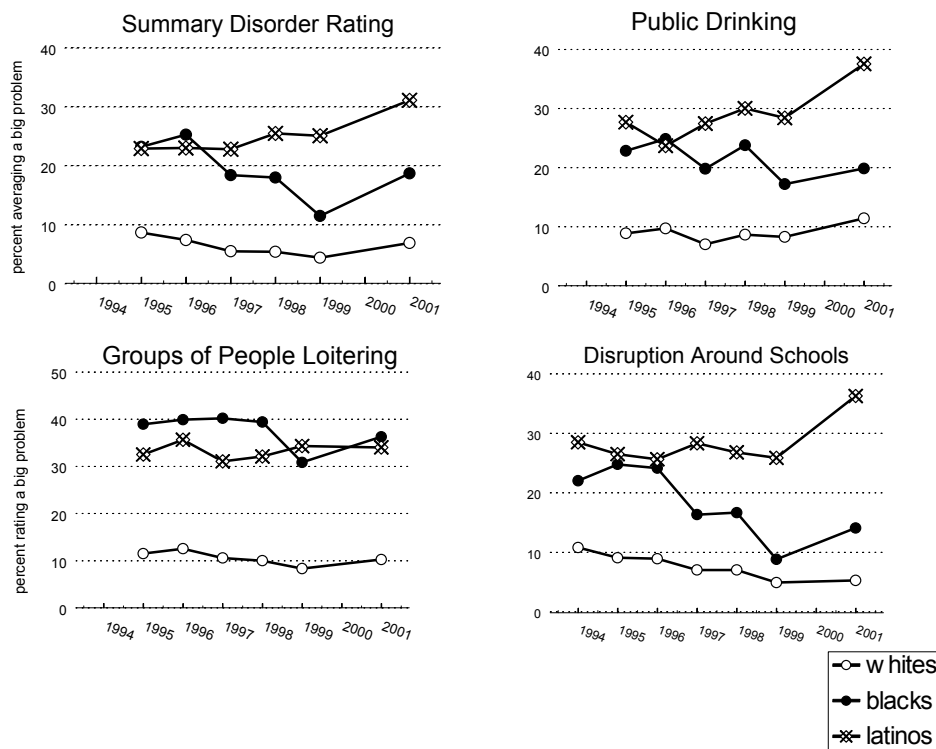

The pattern was different for the city's African-Americans. They expressed substantial concern about social disorder during the early years of CAPS. In 1994, almost 40 percent thought group loitering was a big problem in their neighborhood; the figures for school disruption and public drinking were 22 and 23 percent, respectively. But over time they reported modest improvements in neighborhood conditions. The percentage of African-Americans expressing concern about disruption in and around schools dropped to only 8 percent in 1999, before rebounding a bit to 14 percent in 2001. Concern about public drinking and loitering problems were also down, until African-Americans reported losing ground again in the 2001 survey.

There was little good news for the city's Latinos, however. As Figure 8 illustrates, in 1994 and 1995 African-Americans and Latinos reported about the same level of concern about social disorder; their summary scores for disorder problems were virtually identical. But by 1999, the experiences of the two groups diverged dramatically. Latinos saw none of the declines in school disruption reported by other groups, and reports of public drinking in their neighborhoods worsened considerably. Like African-Americans, they continued to report loitering problems.

In summary, CAPS involves the creation of new partnerships and working relationships between the police and municipal service agencies. Other city institutions – especially the schools – are working in parallel on some of the same problems. New institutions have been created, including an administrative hearings department for handling problem buildings and other quality-of-life violations, and a process for regulating liquor was expanded to include significant community input. By 2001 the balance of concern about neighborhood problems had shifted dramatically in Chicago. This shift is illustrated by the summary ratings for social disorder and physical decay. From the point of view of residents, conditions for whites stayed about the same. They had few serious problems to start with, and fewer at the end. By most measures, conditions improved considerably among African-Americans. But at best, Latinos held their ground during the course of the 1990s. In the face of the unrelenting pressure of immigration, by many measures things actually took a turn for the worse in the Latino community. None of the city's major groups was "average," and the success of CAPS depended on where you lived.

The Police and the Public

One goal of CAPS is to increase popular confidence in the responsiveness and effectiveness of the police. Nationwide surveys report that police generally have the support of the public, and they are held in higher esteem than are many other public officials. But support for the police is not as high among residents of the nation's largest cities, and in the early 1990s Chicago was no exception to this pattern. Opinion about the police is also divided by race, and in the past, Chicago has come off badly in comparisons of the views of whites and African-Americans as well. During the 1970s, the Census Bureau conducted surveys of residents of 26 of the nation's largest cities. In these surveys, the opinion gap between white and African-American residents of Chicago was the largest of any city in terms of public confidence in policing, and as a whole, Chicago stood near the bottom.

This section examines the changing views of Chicagoans during the course of the 1990s and into the new century, as CAPS took root in the city. It examines the depth of racial divisions over policing, and the plan the city had that might address the gulf between whites and other Chicagoans. Police gained significant support during the decade, and did so among all major groups. Much of the explanation for this lay in improving neighborhood conditions. Many – but not all – Chicagoans felt their neighborhoods were growing cleaner, safer and more comfortable, and this rebounded to the benefit of the police.

Some of the best evidence of the impact of CAPS on residents' confidence in the police comes from the first two years of the evaluation, when research could be conducted in the prototype districts where the program was being developed and in matched comparison areas where policing was being conducted as usual. In the prototype districts, the largest changes in opinions about the police were confined to perceptions of their responsiveness to community concerns. The evaluation found that perceived police responsiveness improved significantly in four of the five experimental districts, but not at all in three of their four comparison areas. Perceptions of police effectiveness and demeanor also improved in predominately African-American districts but not in their comparison areas. Combining all of the residents of the prototype districts, attitudes toward the police changed most favorably among African-Americans, who began with fairly negative views on most dimensions. Views of policing also improved among whites, but they were quite positive to start with, and they also grew more positive among renters and home owners. The greatest shortcoming of the program in the prototype areas was among Latinos, who started out even more dissatisfied than the city's African-Americans. Their views did not improve at all. The district in which Latinos involved in the development of CAPS were concentrated was the one district where opinion of the police did not improve significantly.

Measuring Public Confidence in the Police

Since then, the CAPS evaluation's citywide surveys have included a battery of questions probing residents' views of the quality of policing in their neighborhood. Four questions measure perceptions of police demeanor. The questions ask how fair, polite and helpful the police in their neighborhood are, and whether the police are concerned about their problems. Like most of the measures in this section, respondents were given four response categories to choose from, ranging from very positive to very negative. Before CAPS was launched, police in Chicago rated best on this dimension. In 1993, fully 86 percent of the city's residents thought their neighborhood police were very or somewhat helpful, as opposed to not very helpful or not helpful at all. Police came off worst in terms of politeness, for only 71 percent of those who were interviewed granted them a positive rating on that question.

A second measure combines questions concerning police responsiveness. It was based on responses to questions asking how responsive police are to community concerns, whether they are dealing with problems that concern the community, and whether they are working with residents to solve those problems. There were large differences in how Chicagoans rated police

on these three measures. In 1993, more than 80 percent of residents reported that they were responsive to neighborhood concerns. But less than half thought the police were actually dealing with problems that concerned them, and only 39 percent reported that police were doing a good job working with neighborhood residents to solve problems.

The last measure that can be tracked over this nine-year period is police performance, based on responses to questions asking “how good a job” the police are doing at helping victims, preventing crime, and keeping order on the streets and sidewalks. In 1993, Chicago police did not rate highly on any of these aspects of their performance. They did best in terms of keeping order; 56 percent gave them positive marks on this. But only 36 percent reported that officers helped out victims effectively, and only 45 percent gave them passing marks on preventing crime.

Trends in Public Confidence

Figure 9 illustrates trends in Chicagoans’ views of the police between 1993 and 2001. It charts the percentage of respondents who averaged a positive rating on the questions in each cluster.

As noted above, police scored best on their personal relations with the public. Even at the outset, a majority of Chicagoans believed that their neighbors were treated well by police, so there was not much room for improvement on this measure. Before CAPS began in 1993, almost two-thirds averaged a positive score on the police demeanor index; that figure rose to 73 percent by 1999, before dropping a bit to 71 percent. The biggest increase in this category was the percentage who thought police treated residents of their neighborhood politely – increasing from 71 percent to 80 percent over the period. The percentage who thought police were helpful went up by only four percentage points, but that was from 86 percent to 90 percent. By 1999, fully 86 percent of Chicagoans thought police were very or somewhat fair in their dealing with their neighbors.

On the other hand, before CAPS was launched less than 40 percent of Chicagoans had an optimistic view of police responsiveness to community concerns. Responding to this perception was a most important goal of CAPS. By 1995, beat community meetings were held regularly throughout the city, and each police district had formed an advisory committee. City services had been reorganized to support police problem-solving projects by fall 1994. As Figure 9 illustrates, perceptions of police responsiveness to community concerns improved steadily with time; overall, the responsiveness index rose nearly 20 percentage points. The largest increase in this group of questions was the percentage who thought police were doing a good job working with residents to solve problems, which rose from 39 percent to 59 percent over the period. The measure recording the widest recognition asked about police responsiveness to neighborhood concerns: positive ratings on this dimension rose from 81 percent to 88 percent between 1993 and 1999.

Figure 9
Trends in Confidence in the Police, 1993-2001

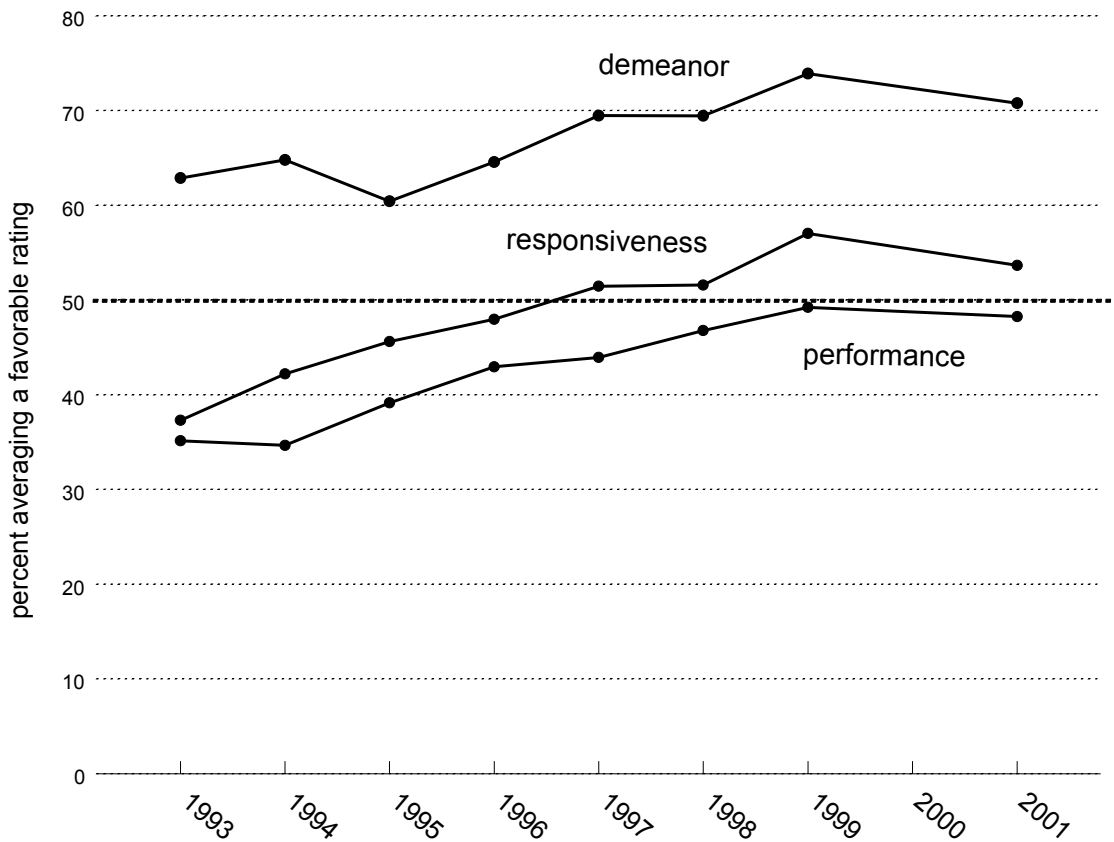

Before CAPS began, Chicagoans were most negative in their views of how well police did their job. But over time, the index measuring this aspect of police service improved significantly, rising from 36 percent to 50 percent. This trend is also depicted in Figure 9. In this category, new police efforts to prevent crime were most widely recognized. Between 1993 and 1999 the percentage of respondents granting them a positive rating on this aspect of their work rose from 45 percent to 60 percent. Reports that police were doing a very good job or a good job assisting crime victims increased from 37 percent to 57 percent. Police got the highest marks for keeping order; positive scores on this measure hit 66 percent by 1999, up from 56 percent in 1993.

These were solid gains. The dark horizontal line highlighting the 50 percent mark in Figure 9 emphasizes that by 2001 a majority of Chicagoans lay in the positive range on three of four measures of public opinion. But the 50 percent mark also emphasizes that there was still ample room left for improvement on these dimensions. After eight years of community policing,

a little less than half the public thought that police were doing a good job at preventing crime, helping victims and maintaining order, and only about 55 percent thought they were doing a good job responding to community concerns. “Helping victims” was the lowest-rated form of service in the surveys; by this measure, police were not seen as responding to the needs of some of their most important customers. Our summary of trends in Chicago is that “the glass” representing the views of city residents about police went from being “less than half full” to “a little more than half full.”

Race and Trends in Public Confidence

The yearly tracking surveys conducted by the CAPS evaluation also gauge trends for selected groups. Figure 10 presents trend data for whites, African-Americans and Latinos on the evaluation dimensions described above. It divides respondents by race (excluding the smallest categories) and presents the percentage of respondents in each group who each year averaged a positive rating on the survey questions in each cluster. It excludes Latinos for 1993, when the city survey could be conducted in English only.

Figure 10
Race and Trends in Confidence in the Police, 1993-2001

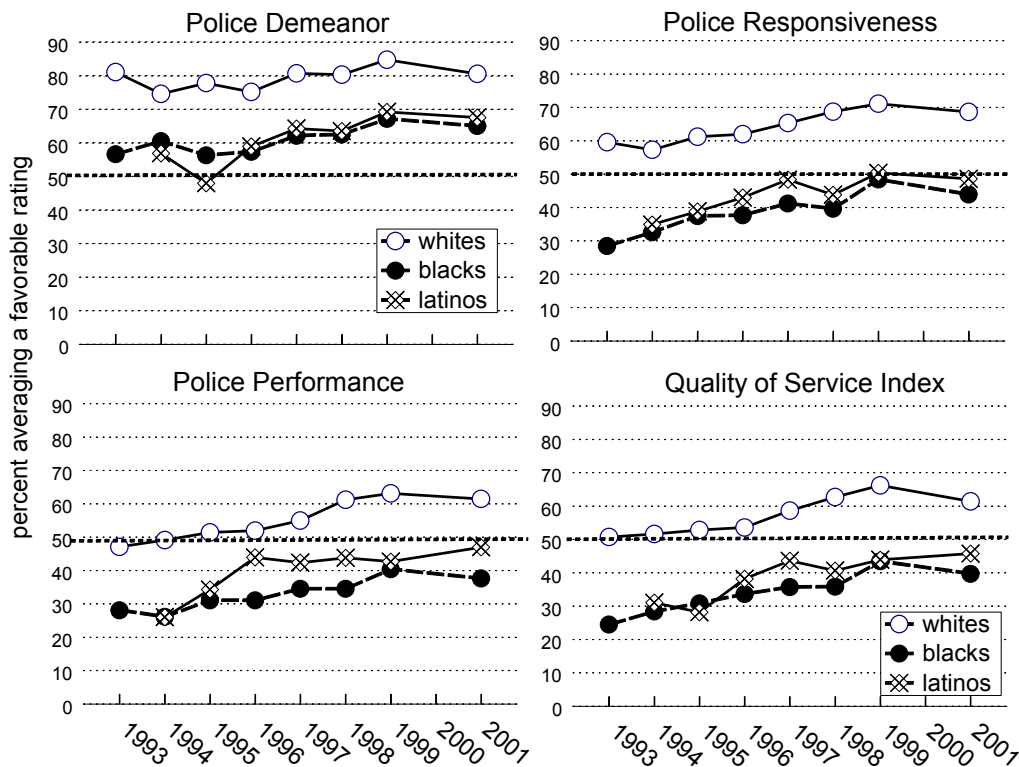

As Figure 10 documents, on most measures there were across-the-board improvements in Chicagoans' views of the quality of police service. The level of opinion varied from topic to topic, but the trend generally did not vary much by race. Whites perceived that police treated people in their neighborhood well even before CAPS began, so there was not much room for improvement there. Latino and African-American perceptions of police demeanor improved by about 10 percentage points and ended near the high note. Whites began the period with relatively negative views of police on-the-job performance, but their views – like those of African-Americans and Latinos – improved by about 10 percentage points. Among African-Americans and Latinos, perceptions of the police changed most on the responsiveness dimension, improving by about 20 percentage points between 1993 and 1999. Among whites the comparable shift was about 10 percentage points, but they began from a higher base.

Thus, by three measures the views of Chicago's major racial groups shifted in a positive direction over the course of the 1990s. These changes ranged from 10 to 15 percentage points, and they were substantial enough that the views of a majority of African-Americans and Latinos almost made it into the positive range on all three measures. But in the end satisfaction rose to this level only on the index of police helpfulness, fairness and concern. Otherwise, only whites ended up consistently above the 50 percent mark. As the city entered the 21st century, Chicago's police department made a great deal of progress, but still had a long way to go.

During the course of the 1990s, Chicagoans of all ages and races grew more sanguine about service rendered by the police. Among those under age 50, opinions about the police improved by 10 to 15 percentage points over this period, and the same was true for older African-Americans. Views of older Latinos remained stagnant over the period, but otherwise assessments of the quality of police service improved over the period even among the most disaffected groups.

Another personal factor potentially linked to assessments of policing is language. As this report documents, conditions for the city's Latinos differed substantially for English and Spanish speakers, and there is reason to suspect that their relationships with police would cleave along similar lines. There are more ways that encounters between police and residents can go awry when they come from different cultures and have a difficult communication gap to bridge. In addition, the city's Spanish-speaking Latinos are less likely than others to know about CAPS, and many live in areas with relatively low rates of beat community meeting involvement – especially in light of the often high crime rates there. However, views of the police improved over time among both groups. There was a 15 percentage point improvement among English speakers and almost a 20 percentage point shift in the positive direction among those interviewed in Spanish.

But while there were general improvements in assessments of the quality of police service in Chicago, at the end of the decade the gulf between whites and others remained unchanged. Based on a summary index combining demeanor, responsiveness and performance measures, about 20 percentage points separated whites from other city residents, compared to

about 25 percentage points six years earlier. The views of many city residents grew more favorable, but division between whites and racial minorities over policing in Chicago hardly shrank at all.

Involvement in Beat Community Meetings

Beat community meetings are one of the most distinctive features of Chicago's community policing program. Beginning in mid-1993, police began holding neighborhood meetings in every beat in the prototype districts. They are regular – usually monthly – gatherings of groups of residents and officers working in the area. By the spring of 1995 these meetings were being held in church basements and park buildings all over the city. In the CAPS plan, beat community meetings are the principal mechanism for building and sustaining close relationships between police and the general public. The meetings are to provide a forum for exchanging information, and a venue for identifying, analyzing and prioritizing problems in an area. They are a very convenient place to distribute announcements about upcoming community events, circulate petitions and call for volunteers to participate in action projects. The meetings also provide occasions for police and residents to meet face to face and get acquainted, a feature facilitated by the formation of teams of officers with permanent beat assignments. As they have evolved, beat community meetings have become venues for regular reports by police to the community on what they had done since the last meeting about problems that had been discussed. They are supposed to provide an occasion for residents to report on their own problem-solving efforts, but – as we shall describe below – this happens fairly infrequently.

Beat community meetings are public gatherings open to all. They are always attended by beat officers on duty at the time, a few team members from other shifts, and the sergeant who supervises the beat team. During June of 2002, a city budget crisis briefly prevented off-duty officers from attending beat community meetings, but that policy was quickly changed in response to complaints by residents and police. Officers serving in specialized units, such as gang officers or detectives, are often present as well, along with a representative of the district's neighborhood relations unit. On occasion, higher ranking members of the district's management team attend. Meetings are sometimes attended by representatives of the city's service departments and area community organizations, local aldermen's staff and organizers from the CAPS Implementation Office. Although districts are required to hold beat community meetings only once every three months, almost all meet monthly. Our 2001 city survey indicated that 59 percent of Chicagoans knew that beat community meetings were being held.

The city and the police department invest a great deal of energy in turning residents out for the monthly meetings. District officers distribute flyers and hang posters in businesses and apartment building entryways. The neighborhood relations offices in the districts encourage organizations to get involved and invite their members, and some develop mailing lists from the sign-in sheets distributed at the meetings. In past years a district arranged for beat maps and a list of upcoming meetings to be stapled to the lids of pizza boxes delivered in their area. In July and September 2002, the department distributed letters to several hundred Catholic churches and Jewish synagogues, requesting that they be duplicated and passed out to their memberships. The

letters were written in English, Spanish and Polish, and they including a map of police beats in the area and a beat meeting schedule. A followup indicated that perhaps 136,000 letters were distributed in response. Recently the police partnered with the Catholic churches to encourage their members to attend beat meetings. With the approval of the Cardinal, an informational letter was sent to churches to be distributed to service attendees. Efforts to involve members of the Jewish, Protestant and Islamic faiths are ongoing. On occasion, school children have brought home announcements of beat community meetings, and announcements have been distributed by churches. Computer-savvy residents can check the meeting schedule for their beat via the Internet. The CAPS Implementation Office, originally housed in City Hall and later within the police department, sends field workers door to door in selected areas, encouraging residents to attend. The newsletters and television spots advertising CAPS emphasize the importance of attending beat community meetings.

Over time, the variety of meetings involving police and the public has grown. A few large and diverse beats have been subdivided and regularly hold separate meetings. Beginning in 2002, meetings in a number of beats plagued by low turnout were merged with those in adjacent beats to boost attendance. The department also began to experiment with holding meetings at new times and days, including – for the first time – on Saturdays. Beats that are largely commercial in character (such as the downtown area) meet less often, and many who attend there represent businesses and building security units. Heavily commercial police districts have a specialized business liaison officer to handle these kinds of events. In some beats, advance sessions are held with neighborhood activists or civilian “beat facilitators” to craft action plans and prepare for beat community meetings. Facilitators are selected by the police to assist them in planning their agendas and running beat community meetings. Police districts and individual beats sponsor other kinds of assemblies as well, including marches; rallies and block parties that involve considerable numbers of residents; smaller meetings between police and neighborhood activists or ministers; and neighborhood watch and cell-phone patrol groups.

Our surveys of city residents indicate that awareness of beat community meetings by members of the public was stable during the course of the 1990s but dropped a bit in 2001. The biggest gap in awareness that meetings are taking place is between home owners (at 71 percent in 2001) and renters (only 51 percent). Awareness is high among Chicagoans over age 50 and low among those who did not graduate from high school. African-Americans have consistently outpaced whites (by about five percentage points during most of the 1990s) and Latinos (by 15 percentage points for those interviewed in English, and by 20 percentage points for those interviewed in Spanish).

Trends in Beat Community Meeting Participation

This section of the report examines trends in citizen involvement in beat community meetings. It is based on data drawn from brief forms completed by officers for beat community meetings. These forms detail where and when meetings were held, who was there and what was discussed. They have been a reliable guide to the basics of the meetings, based on comparisons

of the forms and reports by observers for the sample of beat community meetings they attend each year. Occasionally paperwork gets lost, but by keeping track of meetings it is possible to develop estimates of attendance when the data for a particular session are missing. These estimates are based on the average attendance at other meetings in the beat during the same season of the year; these seem appropriate because beat community meeting attendance has proven to be very stable over time. For the most recent 12 months of data, an average of 254 beat community meetings were held across the city each month.

Figure 11 charts trends in beat community meeting participation since January 1995. The left axis reports monthly attendance figures, while the right axis presents the cumulative total of attendees since the starting date. Based on these estimates, Chicagoans attended beat community meetings about 59,000 times during 1995 and 61,000 during 1996. The figure for 1997 was almost 65,000, and it was more than 69,000 for 1998. In 1999, 67,000 persons showed up, and in 2000, 66,000. During 2001, residents turned out 66,600 times. As the right axis on Figure 11 indicates, over the 90-month period between January 1995 and June 2002, more than 488,000 Chicagoans attended more than 21,000 beat community meetings.

Figure 11
Trends in Beat Community Meeting Attendance, 1995-2002

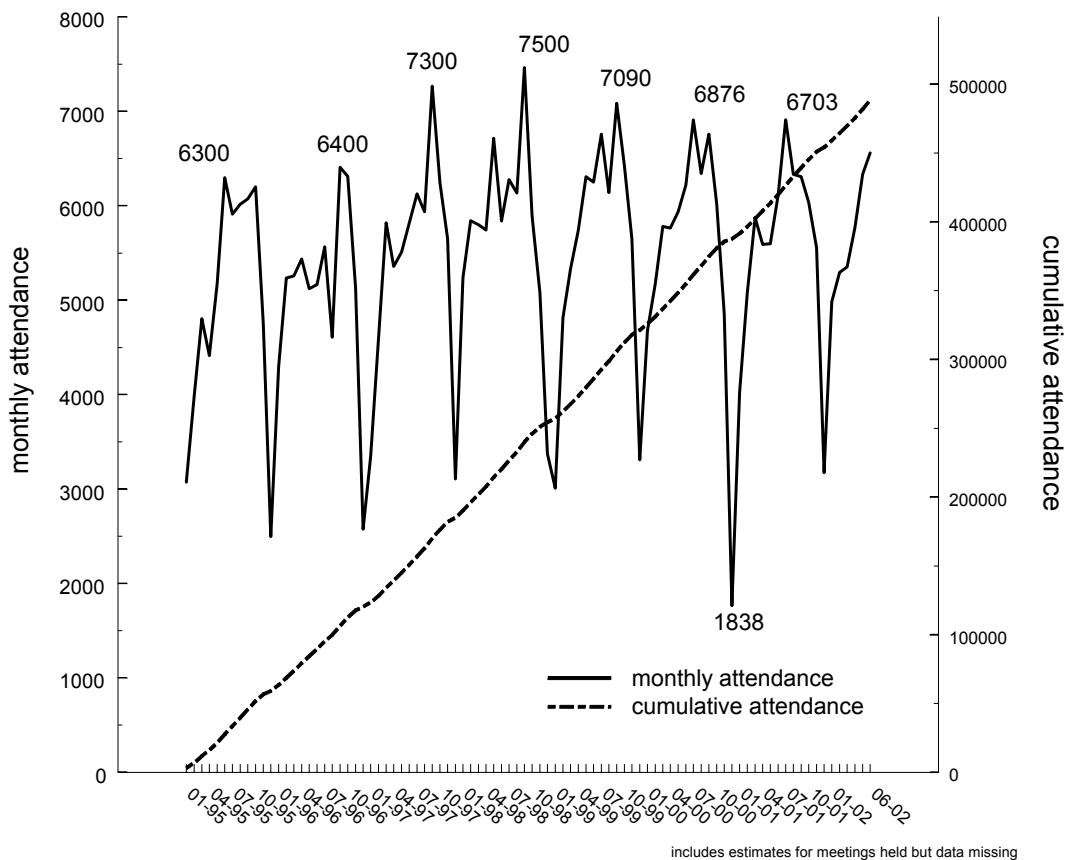

As Figure 11 illustrates, beat community meeting attendance is very seasonal. It is lower in winter months than during the summer, and the lowest attendance month is always December. December 2000 was the lowest turnout month on record; only 1,838 people attended beat community meetings during that month of near-record cold and near-record snowfall. Attendance is also low in December because many beats that usually meet in the second half of the month usually cancel their meeting due to the holidays.

The “head counts” that can be extracted from police records are silent on how many new participants come each month and how many are regular attenders. Questionnaires we distributed at beat community meetings during 2002 found that the average participant attended 5.7 meetings during the previous year. (There is more discussion about this study later in the report.) A citywide survey conducted in spring 2001 also asked about beat meeting participation, and because it queried a random sample of the population this survey tells us something about people who do not show up at all. In the 2001 city survey, 16 percent of Chicagoans indicated that they had attended at least one beat community meeting in the previous year.

High and Low Attendance Beats

To examine patterns of high and low attendance we combined meeting reports for each of the city’s beats for all of 2001 and then calculated their average monthly attendance rate. To compare attendance across beats it is necessary to take account of their varying size. The boundaries of the city’s police beats were originally drawn to equalize workloads, measured by a formula using calls for service, so beats vary widely in population. For example, in 2000, the bottom 20 percent of the city’s beats in terms of population averaged 4,400 residents, while the top 20 percent had an average of more than 19,000 residents. In general, only adults come to beat community meetings, so the denominator for each beat’s attendance rate is the number of residents age 18 and older. These population figures were drawn from the 2000 census. This section examines patterns of attendance by comparing rates of attendance to demographic, crime and other data on the beats. Most measures were logged to account for skewed distributions. In these analyses, nine beats are excluded because their residential population is very low; they are located either in industrial areas or in the downtown business district.

Beat community meeting attendance rates were often highest in places that could benefit most from them. Rates were the highest in the city’s predominately African-American beats and lowest – once population is taken into account – in predominately white areas. In general, attendance rates were higher in lower-income, higher-crime areas where people did not have much education. They were also high in areas where other institutions, including schools and the health care system, have failed to serve residents well.

Figure 12 illustrates these relationships. It charts both the data for beats and the regression line that best describes them. Figure 12 documents the link between beat meeting attendance rates, crime and affluence. Attendance was higher in poor areas. For example, the

Figure 12
Factors Associated With Beat Community Meeting Attendance

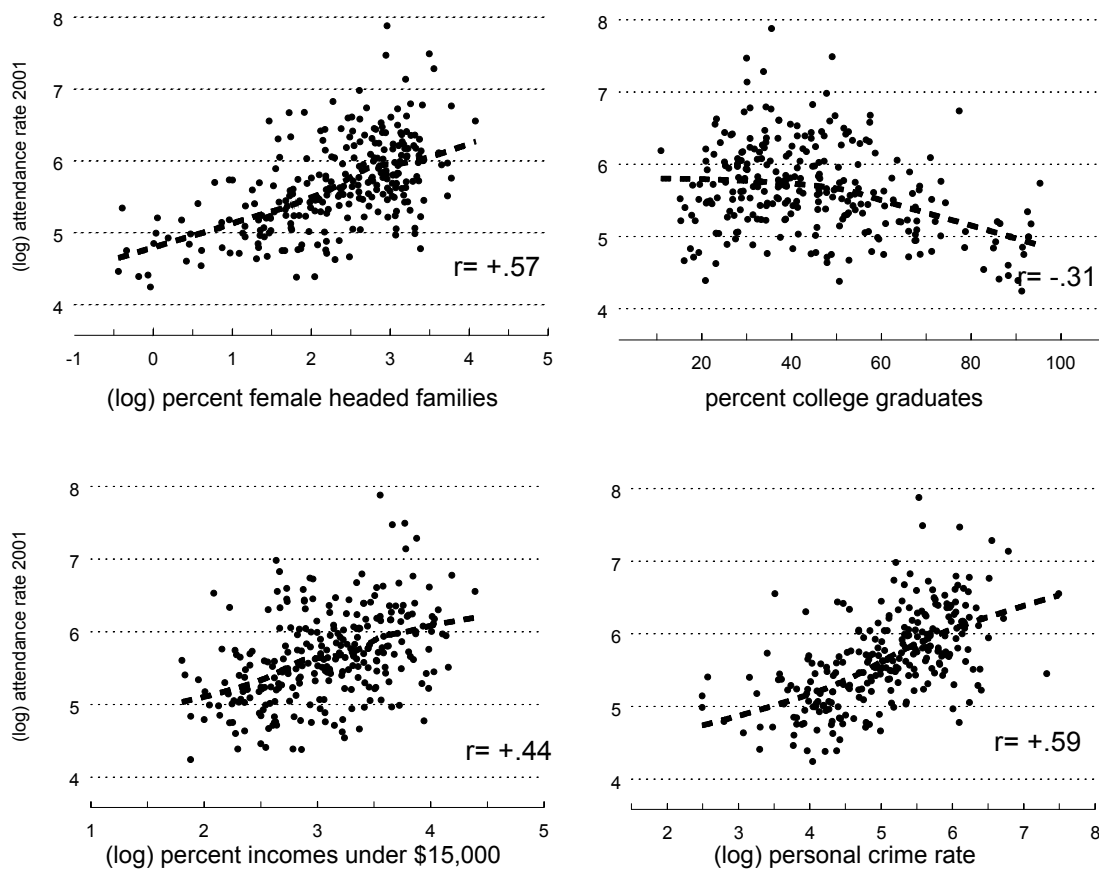

correlation between attendance rates and a common poverty measure – the percentage of families headed by women – was $+0.57$. The lower-left panel illustrates the relationship between meeting attendance and another poverty measure, the percentage of residents with incomes below \$15,000; the two were correlated $+0.44$. Another panel documents that beat meeting attendance was lower in beats where more residents had a college education; the correlation between the two measures was -0.31 . Interestingly, the link between involvement and home ownership, a factor often strongly associated with participation in volunteer and civic activities, was virtually nonexistent (-0.09). Beat meetings also provided an alternative to the traditional way of influencing government in Chicago: voting in local elections. Attendance rates were somewhat related to the turnout rate for local elections ($+0.29$), but attendance was highest in beats offering the least support for the incumbent mayor in the 1995 election (-0.53).

The success of beat community meetings in areas where other institutions have not worked well is illustrated by the relationship between beat community meeting attendance and school and health data. Attendance was higher in areas where test scores for the city's public

school students are low, truancy rates are high and graduation rates are poor. The correlation between attendance rates and a composite achievement test score for the school serving each beat was $-.34$. Attendance was higher in areas where residents have health problems, including high rates of gonorrhea and tuberculosis, and where infant mortality is high. The attendance-infant mortality correlation was $+.49$, for example. Turnout was also somewhat higher ($+.38$) in beats where city land use files rate a large proportion of buildings as being in bad condition, and in beats where many parcels of land sit vacant ($+.41$).

These findings are important because they run counter to a common form of bias in social programs. Voluntary, community-based programs typically overrepresent the interests of better-off, home owning and well-established areas. This is so common that it is the norm to expect a “middle-class bias” in volunteer-based social programs. Around the country, it has proven difficult to sustain the involvement of residents of communities that need community policing most. However, in Chicago turnout rates for the city’s community-policing program are positively related to many measures of need. They are especially high in poorer areas with bad housing, in predominately African-American beats, in areas where schools and health programs are not effectively meeting residents’ needs, and in places that are less influential in politics.

Participation was also highest in high-crime areas. For example, attendance rates were correlated $+.42$ with the murder rate and $+.59$ with the rate for gun-related crimes of all kinds. The relationship between attendance rates and the overall personal crime rate ($+.58$) is presented in the lower-right panel of Figure 12. The link between high-volume property crimes and participation was similar; the correlation was $+.40$ for property crimes of all kinds and $+.30$ for residential vandalism. In multivariate analyses, attendance was related both to crime and deteriorating housing. Statistically, crime was the strongest factor explaining participation rates. High turnout in high-crime areas is important because it runs counter to pressures that historically have shaped police-community relations in poor and disenfranchised communities. Residents there have too often had a troubled relationship with the police who serve them. They are more likely to think they do not get good service, and that police are abusive toward their neighbors. Organizations that represent them may also not have a track record of cooperating with police, since their constituents too often fear them. Our surveys indicate that many of these beliefs are still quite strong in poor and minority communities, but turnout has still been strong in many places that need help most.

What Happens at Beat Community Meetings?

During the summer of 2002, we assessed the extent to which beat community meetings are reaching their goals. Observers attended a large sample of beat community meetings to make note of what happened there. The sample of 130 beats involved in the study was selected randomly from the city’s 270 residential beats, and the sample beats mirrored almost exactly the demographic and land use features of the city. Observers completed a structured observation form each time. On the form they recorded the number of police and residents who attended as well as the roles played by police and other city employees. Using a checklist, they noted issues that were raised by citizens during the course of the meeting. They reported on the

languages employed at the meeting, the distribution of printed materials, and leadership roles played by police and residents. Our observers noted which participants identified problems and solutions to problems. They judged the effectiveness with which the meetings were run, and whether efforts were made to involve residents in problem-solving projects.

During meetings the observers distributed questionnaires to residents and police who were present. Questions for residents focused on conditions in the beat, their personal involvement in CAPS and their assessments of the meetings they had attended. Resident questionnaires were available in both English and Spanish. Police were asked many of the same questions, and they were also asked about working conditions in their district and about their assessment of the department's new information technology initiative. A total of 3,706 residents and 643 police officers were surveyed.

A special feature of the 2002 study was that observers were to attend each sample beat at least twice to increase the reliability of the observations. They completed an observation form each time, and at follow-up visits offered survey questionnaires to police and residents who did not complete one initially. More than two visits were required in some circumstances. Occasionally, the meetings we sampled were devoted to special events, or marches or picnics were held in their stead. On some occasions the agenda of a meeting was so full that our observers were not able to distribute the resident and officer surveys. Intense heat during July 2002 discouraged attendance in many places, so additional observations were scheduled in order to survey an adequate representation of meeting participants. The profile of beat community meetings presented here is based on the first two meetings we observed in each beat, so that they each contributed equally to the analysis.²

Many of the beat community meetings we observed were held in local churches (28 percent), park district field houses (23 percent) and schools (15 percent). An average of 25 residents attended; the smallest meeting that was held was attended by three residents and the largest by 125. An average of seven police officers (and as many as 12) were there. Almost all meetings began at 6:30 or 7 p.m., and the average gathering lasted 58 minutes. Police have attempted to accommodate the city's burgeoning Latino population by producing Spanish-language CAPS materials, but handouts were available only in English at 83 percent of the meetings. Also, only 4 percent of the meetings we attended featured even a little translation of the proceedings into any other language.

In surveys distributed to those who were present, we asked how often they had attended beat community meetings in the past year; the average was 5.7 meetings. Twenty percent indicated that this was their first meeting, while 9 percent indicated that they attended every

² A detailed description of the 2002 beat community meeting study can be found at the Institute for Policy Research Web site (www.Northwestern.edu/IPR/policing.html). It includes copies of all the surveys and forms used in the study.

month. Frequent attendance is crucial to overall attendance at beat community meetings, because those who come often contribute disproportionately to the yearly attendance total. For example, the 9 percent of residents attending every meeting contribute 23 percent of the total who attend over the course of a year, because they are always there. In the survey, we classed those who report attending eight times a year or more as “frequent attenders.” They make up 30 percent of attendees at any given meeting, but over a year’s time they constitute 62 percent of those who show up. Older males are the most frequent attenders, along with home owners and whites. Those with a high school education but who did not go to college come most often, as do long-term residents of the neighborhood.

What Do They Talk About?

Using a structured recording form, observers noted the topics that were discussed at the meetings. Only issues raised by residents are examined here.

Drugs are one of the most commonly discussed problems; residents expressed concern about drug sales or use at 62 percent of the meetings. Our observer noted in one beat:

A quite lengthy discussion took place about conditions on _____ Street between _____ and _____. Several residents complained about the adults as well as youths in the area selling narcotics. They were selling the narcotics on the streets. The buyers would then proceed to an abandoned building on the block to use the drugs. The drug trafficking caused a lot of traffic congestion on the block. Drivers would literally have to wait until the dealers sold their product and the customer was happy. The residents said that in the last few months, the problem seemed to escalate. The narcotics were being sold in greater numbers and at all times of the day. The abandoned building that addicts were using became a haven for squatters and their children. As a result of all the discussion about that problem, the police decided to make that their new mission. They promised increased police patrol. The tact sergeant also promised more surveillance and undercover work in that area.

People who come to beat community meetings where drugs are discussed reported in our questionnaires that they are concerned about many other types of problems as well, including street crime and gang violence. Drug problems are discussed most frequently in meetings held in poor and predominately African-American beats where violent crime rates are high and where many crimes that take place involve guns. These are also beats where residents report the most dissatisfaction with police working in the area.

Physical dilapidation is another frequent topic at beat community meetings, discussed by residents 47 percent of the time. This category includes concern about abandoned or run-down buildings, abandoned cars, graffiti and other forms of vandalism, litter and trash, illegal

dumping, loose garbage in alleys and overflowing dumpsters. An observer made this note during a beat community meeting:

They . . . had very serious concerns in regard to a dilapidated building in their block that was being used for drug sales. The drug seller's people were also squatting in the basement of the building. The main concern was that the four adults who were squatting also had three children under the age of four with them. The building had no running water or working electricity, but the neighbor had seen the landlord trying to assist the squatters to tap into the water. The neighbor who owns the building next to it complained about the rats in this dilapidated building. He stated that contact had been made with 311 but there had been no response. At the conclusion of this conversation the police proceeded to leave, stating they were going to this building to check all this information out. This neighborhood beat community meeting was filled with frustration from residents, the facilitator and police. The facilitator can be quoted about the residents' overall feeling: "These people are prisoners in their own neighborhood."

Discussion about physical decay is most frequent in poorer areas that have many vacant buildings and low rents, and that are plagued by both personal and property crime as well.

By contrast, **parking and traffic** problems were discussed most frequently in better-off areas. In the 44 percent of beats where it was discussed, residents expressed concern about traffic congestion, parking and double parking, speeding, running stop signs, and reckless or drunken driving. Discussions of traffic problems predominated at a meeting attended by one of our observers:

A resident discussed a problem near a school on her block. She said that parents waiting to pick up their kids would double park in front of the school and back up traffic for miles. When residents asked these people to move their cars and drive around the block to wait, the drivers usually did not respond. Some of these parents park in a private parking lot next to the school. The officers said that they would consider heavily ticketing the area, and that if they did so at the school then they would have to heavily ticket the whole beat. One resident suggested that she videotape some of these cars and show how much chaos they are causing in the street. These tapes could then possibly be shown at the school's annual open house to parents. Another resident discussed the problem of people running a stop sign near her home. She said that many children cross the street there after school. She sees several cars a day fly through the intersection. The woman asked the police if they could post a car there during the afternoon and hopefully stop some of this. An officer said they don't have the manpower to do this. They drive one-man cars, and they can't just sit on a corner for an hour each day. They are needed at too many other places. The woman suggested that they park an empty car near the corner, but the officers said they don't have enough squad cars to

just leave one parked. The police suggested maybe the school should post a crossing guard at the intersection.

Parking and traffic problems are discussed most frequently in areas where there are relatively few problems. There, few issues other than parking and traffic concern residents. The police who attend meetings in these beats agreed, for they also give them low problem ratings. Beats emphasizing parking and traffic have low meeting turnout rates, and few who attend report much CAPS activism. They are predominately higher-income, white collar areas with high rents and home values.

Beats where discussion focuses on **gangs** have a much different profile. Overall, gangs and gang-related violence were brought up at 29 percent of the meetings we observed.³ The specific concerns that were voiced included intimidation by gangs, outbreaks of gang graffiti, gang recruiting and gang loitering. Our observer noted:

It was at this point that the attendees became really vocal, particularly when a man brought up the gang problems in the neighborhood. The attendees began to give personal accounts of sightings of gangs, particularly around the park district. For example, the man who brought up the gang issue said his wife was nearly shot outside the intersection of ___ and ___ by gang members when waiting for their daughter to return from school. He had lived in the neighborhood for 18 years and had called 911 so many times he had “worn out the buttons on his phone.” He was extremely frustrated with the police response to the gang situation and referred to the neighborhood as a “war zone.” In particular, he felt that the neighborhood was “losing control of the park.” The subject of police response to the gang situation was apparently a hot issue with many of the attendees. Another man said that he had seen gang members carrying guns and using young gang members as lookouts. In addition, there were complaints that the squad cars and the police were not effective deterrents to the gangs.

In Chicago, gangs are a visible problem in heavily Latino beats. Residents who come to meetings there are also vocal about graffiti problems and public drinking. Gang problems are frequently discussed in areas that are home to large families, where schools are overcrowded and where unattached males are also concentrated. Gang problems are most frequently discussed in areas where people have little education and many households fall in the Census Bureau’s “linguistically isolated” category – that is, no one in the household speaks English at all.

Concern about **property crime** was voiced at 38 percent of the meetings we attended. The most frequent issues are home and garage burglary, break-ins of cars and auto theft, car

³ Gang involvement in the drug trade was classified as a drug problem.

vandalism and general theft. Confidence games aimed at senior citizens are also discussed. Our observer noted:

Residents said that two nights before, some people stole a car in their back alley. These people then went on a joyride through the alley, knocking over garbage cans and damaging property. They finally drove out of the ally, dumped the car in an abandoned lot and set it on fire. The residents said that they called 911 a couple of times and that the police only showed up after the car exploded. They were questioning why the police didn't show up right away, saying that if they had, the police could have arrested the individuals before the car was set on fire.

Property crime is a subject for discussion in better-off areas of the city, and in predominately white beats that are home to concentrations of senior citizens. On the other hand, residents who attend beat community meetings there generally report little concern about personal crime.

Personal crime was discussed at just 22 percent of the meetings. The issues raised by residents included robbery, purse snatching, domestic violence and sexual assault.

One resident brought up the recent attacks against elderly people in the area. Teenagers have been asking older people if they have change for a \$20 bill, and when the people reach for their wallets, the kids hit them with bats and take their money. This has been happening while the elderly people are walking, driving or waiting at bus stops.

Various forms of **social disorder** were discussed at 89 percent of the meetings. This category included a long list of minor offenses, as well as conditions that are not criminal but that frequently disturb neighborhood residents. The list of problems discussed includes prostitution, public drinking, panhandling, curfew or truancy violations, disturbances by teenagers, public exposure, gambling, trespassing, noise and landlords who lose control of their buildings. Concern about social disorder is so widespread that it is not closely associated with any particular neighborhood feature. In just one beat our observer noted:

The first problem discussed was a large group of children running amok on a particular block. The resident said the group sometimes numbered in excess of 40 children. These kids would leave garbage in the yards and streets. Another problem, possibly related, took place after school was dismissed for the day. A resident complained that after school, streets would be mobbed with children running around and causing trouble. These children broke the resident's windows twice in the same week as well as at other times. Another complained about the sale of tobacco to minors at a local convenience store. He said that minors could purchase individual cigarettes at this location and that he was worried that these cigarettes might contain marijuana.

In another area:

Two residents complained that there was a huge party going on in the street in front of their home. They said there were a few hundred people drinking, smoking marijuana and drag racing. They were also urinating on front lawns and causing trouble on the block. A building owner at the meeting said she is having a problem with her building. She said there are human feces all over in front of and next to the building.

In a third:

The next topic of discussion was prostitution rings, including those in which children were being pimped out to do sexual favors in various alleys and on streets around the beat. One resident complained that she saw the prostitutes every day behind her garage engaging in sexual activity with various men. She said she was trying to get her neighbors and tenants involved but was not sure how to stop it.

One of the issues residents discussed was **policing**. In fact, negative comments or complaints about the police were aired at 44 percent of the meetings. The most frequent complaints were about the speed or quality of police responses to 911 calls. This was followed by complaints that there were not enough police serving the area, or that they were not visible enough. Negative comments about the police were more common in predominately African-American areas that are neither extremely poor nor well-off – where many lower-income home owners are concentrated. Crime rates are not particularly high in these areas, although school truancy is. Surveys of officers at the meetings reveal that they do not come to beat community meetings very regularly and have little contact with residents who do, except when they attend.

CAPS Activism

Beat community meetings are intended to serve as a springboard for community activism. CAPS envisions police and residents working in partnership to solve community problems, and beat community meetings provide the principal forum for making plans and getting everyone involved.

To assess the extent to which they are getting involved, the participant survey included questions about various forms of CAPS activism. Residents were asked if they had participated in each activity during the past 12 months “in your beat or district.” Overall, 64 percent of those who attended reported participating in at least one of the activities that were listed. Table 1 presents detailed findings from the survey.

Table 1
Beat Community Meeting Participant Activism

Percent of Meeting Participants Involved in CAPS Activities in the Past 12 Months			
Aggressive Activism		Involvement in CAPS	
marches or rallies	25	a city or area Neighborhood Assembly	18
prayer vigils	13	CAPS fairs, forums or education programs	16
smoke outs, CAPS picnics or barbeques	12	attended court for court advocacy or a Court Advocacy subcommittee meeting	11
positive loitering	9	Vote Dry or liquor control projects	12
parent patrols or walking school bus	6	worked with the CAPS office to organize a neighborhood group	14
neighborhood patrols or watches	21	contacted police or elected officials about a problem	39
percent involved in aggressive activism**	43	percent involved in CAPS neighborhood projects**	53

** See text for definition of activism measures.

An analysis of patterns of activism found that activities described in Table 1 actually fall into two distinct clusters. One featured several kinds of aggressive activism. They are listed on the left side of Table 1, and included marches, prayer vigils, smoke outs, positive loitering, parent patrols and neighborhood watches. Participating in marches and rallies was the most frequent activity in this category. Twelve percent reported participating in “smoke outs, CAPS picnics or barbeques.” Most of these events are aggressively anti-crime, for they are deliberately held in the midst of street drug markets or prostitution zones and are intended to drive both sellers and their potential customers from the area. “Walking school buses” are parent groups that walk through a neighborhood each morning “picking up” youths and escorting them to school. Neighborhood watches or patrols were surprisingly popular, reported by 21 percent of those attending. Overall, 43 percent of those attending beat community meetings reported being involved in at least one of these efforts.

Activities reflecting involvement in CAPS neighborhood projects are listed on the right side of Table 1. These ranged from attending neighborhood assemblies to being a court advocate, working on liquor control projects and organizing neighborhood groups. Court advocacy is an official CAPS project that is sponsored by the districts’ advisory committees, and 11 percent of those attending reported some involvement in that effort. Neighborhood assemblies and CAPS fairs or forums are events organized by the CAPS Implementation Office, a civilian-staffed arm of the police department. “Vote Dry” is the common label for efforts to close down troublesome

liquor establishments in the city using a referendum process, and 12 percent indicated they had been involved in that or some other liquor control project. Overall, 53 percent of those attending beat community meetings in the summer of 2002 reported being involved in at least one of those activities. “Contacting police or elected officials about a problem,” which is a fairly passive form of involvement, was the most frequent activity reported in the survey (at 39 percent), and it fell in this category.

Two other activities included in the questionnaire are not listed in Table 1, because they did not fall into either of these statistical clusters. In addition to those, 23 percent of the residents who were surveyed reported that they had participated in a CAPS community clean-up or beautification project, and 10 percent said they were involved in “other efforts to close a problem business.”

There were some differences in patterns of involvement in these two clusters of activities. Older, long-term residents of the community tended to be involved in neighborhood activities but not in aggressive activism. Men and African-Americans were more likely than their counterparts to report being involved in both neighborhood and aggressive activism. Reports of activism were highly related to being a frequent participant in beat community meetings and in working with other beat community meeting regulars in activities in the community.

A more significant issue is whether CAPS activism is concentrated where it is needed most or higher in better-off areas of the city. To examine this, we created beat-level measures of participation in CAPS neighborhood projects and aggressive activism. This confirmed that beats that are cohesive – that is, beats where those who come to meetings attend frequently, know and work with one another outside of the meetings, and belong to other kinds of community organizations as well – spawn more CAPS activism. Beat activism is also more common in lower-income, African-American areas of the city, where health problems and bad school outcomes are also issues. Activism is higher in areas with high rates of violent crime, and where neighborhood amenities such as grocery stores and restaurants are harder to find.

In short, like beat community meeting participation rates, both aggressive activism and involvement in CAPS neighborhood projects were more common in places needing it most. This is a finding that again runs counter to a common form of bias in voluntary social programs. In Chicago, areas at risk enjoy both higher rates of participation in meetings and higher rates of activism by those who attend.

Model Beat Community Meetings

The police department has a vision of how beat community meetings are to be conducted and what is supposed to happen there: they are to be a place to share information, identify problems and make action plans. Both police and citizens are expected to take responsibility for problem-solving projects, and beat community meetings provide a venue for everyone to review their progress and assess how well they are doing. Earlier reports in this series documented that many meetings did not go according to plan.

One goal of the 2002 study was to examine how closely activities in the field reflected the plans made downtown. To do this, the observation form completed at each meeting gathered information on the elements of a “model meeting.” The data can be used to rate the extent to which each resembled an ideal gathering. The rating scale is based on 10 aspects of the meetings; these are summarized in Table 2.

Some of the meeting components summarized in Table 2 represent the “mechanics” of the meetings. Were meetings well run? Observers reported that there was a clear agenda, either printed or clearly announced, for 84 percent of the meetings. On the other hand, minutes or summaries of the previous meeting were presented in some fashion at only 30 percent of them. (This measure is not included in the index .) Under the department’s guidelines, for each beat a civilian “facilitator” is supposed to be identified, among whose tasks is to help organize and conduct public events. The observers noted that civilian facilitators actually were present at 75 percent of the meetings. Observers also judged the overall effectiveness with which the meetings were run and concluded that about 12 percent were poorly conducted. Just over 55 percent were fairly effectively managed, and 32 percent were judged to be very effectively run. The police officers who played leadership roles got somewhat higher marks than the civilians; just over 60 percent of the civilian leaders at the meetings were judged to be fairly or very effective,

Table 2
Components of a Model Meeting

<i>Clear Agenda</i>	Was there a printed or verbal agenda for the meeting?	<i>Resident Feedback</i>	Did residents report back on previous problem-solving efforts?
<i>Information Shared</i>	Were crime maps or crime reports handed out?	<i>Officer Feedback</i>	Did police officers report back on previous problem-solving efforts?
<i>Civilian Leadership</i>	Was there a civilian facilitator for the meeting?	<i>Problems Identified</i>	Were problems or issues identified at the meeting?
<i>Volunteers Encouraged</i>	Were volunteers called for or sign-up sheets passed around?	<i>Solutions Identified</i>	Were solutions proposed for the problems that were identified?
<i>Action Component</i>	Did residents leave the meeting with a commitment to future action?	<i>Meeting Effectiveness</i>	Rating of the overall effectiveness with which the meeting was run.

compared to 85 percent of police leaders. However, meetings led by civilians or jointly between police and a resident were judged on the whole to be better run, but they constituted only 5 percent of the meetings. There was also a fair degree of information sharing by police. Department guidelines call for crime information to be distributed at beat community meetings, and this usually happened. The department's crime analysis system can produce a variety of reader-friendly maps, crime lists and reports, and our observers reported that either crime maps or printed crime reports were passed out at 88 percent of the meetings.

There was a great deal of variation in the extent to which different elements of Chicago's problem-solving model were enacted at beat community meetings. All of the officers in the department's patrol division have been trained to employ a five-step process that features identifying and analyzing problems, developing and implementing solutions to them, and assessing the effectiveness of what they have accomplished. These problem-solving steps were also woven into the curriculum of the massive training program for neighborhood residents that was conducted in 1995 and 1996. Observers found that the most frequently met standard on the list presented in Table 2 was that there was a discussion of beat issues: problems were identified at every meeting. Most problems were identified by residents who were present, and police dominated the discussion of problems at only 11 percent of the meetings. There were usually discussions about how to solve them as well. The observers noted that solutions were proposed for problems that were discussed at 77 percent of the meetings. As in our earlier studies of these meetings, most solutions (45 percent) were proposed by police. Residents proposed most of the solutions 12 percent of the time, and did so jointly with police at another 20 percent. When it came to debating or "brainstorming" about solutions rather than just announcing them, police were also more likely to be involved than were residents. Residents debated solutions at half of the meetings, the police at almost 70 percent.

Follow-up reports at beat community meetings are important aspects of the process. Reports on problem-solving efforts presented at beat community meetings serve several functions. These discussions help make it clear to participants that attending "pays off"—that they should attend because something actually happens as a result of the meetings. Reports on the problem-solving efforts of residents help sustain the enthusiasm of participants for the process, for it recognizes their contributions and may encourage others to join in. Beat community meetings also provide a forum for residents to hold beat officers accountable. Calling for reports on their efforts since the previous meeting helps savvy residents ensure that police and city service agencies actually follow up on problems discussed at these sessions. The observers found that police contributed reports of their efforts fairly often; they reported on their problem-solving activities at 74 percent of the meetings. However, only 47 percent of the meetings featured residents discussing their own efforts.

Because sustaining effective citizen participation in problem solving has proven to be difficult in many areas of the city, the observers also kept note of the role of beat community meetings in mobilizing participants. One factor they watched for was whether volunteers were called for or whether sign-up sheets were distributed at the meeting to engage participants in particular activities. They found that this happened at 24 percent of the meetings. On the other

hand, other community events or activities were announced at 60 percent of the meetings, and attendees were encouraged to use the city's nonemergency 311 services hotline at 61 percent. Observers also made a critical summary judgment at the end of each session: did residents leave the meeting with a commitment to future action? When participants leave knowing what needs to be done as well as what their role is in those efforts, beat community meetings may have a greater impact than when there is no commitment to any clear action. Observers were to assess each meeting on the basis of calls for volunteers, announcements of other meetings or activities, and action plans that were discussed. Based on these criteria, they judged that only 26 percent of the meetings met the standard of having an "action component."

To summarize all of these factors, a model meeting index was created by summing indicators of each of the 10 components listed in Table 2. The index set a high standard by only counting meetings that were judged to be "very effective"; otherwise, the components of the index were either present or absent in each case. When the elements of the meetings were combined, the usual meeting met a bit more than half of our criteria: the average meeting score was 6.2, and the median was 6.0. Across the beats, none of the meetings received a score of zero, and a total of 13 percent received four points or fewer. At the other end of the scale, 3 percent of the meetings received a perfect score, and 24 percent received a score of eight, nine or 10.

What seemed to contribute to better meetings? One factor that has been identified in past reports remains important: civilian leadership. Meetings that were chaired jointly by residents and police best fit the model, with an average rating of 7.4. They were followed by those run by residents (6.6), while those run only by police scored an average of 6.0. However, residents principally conducted only 37 percent of the meetings, and did so jointly with police only 5 percent of the time. Among those run by the police, the most highly rated meetings were run by beat team sergeants, while members of the Community Policing Office ran the lowest-rated meetings. Among the components of the model-meeting index, civilian- or jointly led meetings were more likely to have clear agendas and discussions of solutions to the problems that were discussed. They were also more likely to feature descriptions by residents about their own problem-solving activities and more calls for volunteers for various activities, and they were more likely to end with a commitment to action on the part of residents. Model meeting scores were not linked to the predominate race of a beat or to any racial disparity between residents and the police.

Representing the Community

In Chicago's model, beat community meetings are the vehicle for grass-roots consultation and collaboration between police and residents. CAPS resolves a potentially complicated question – "who is the community?" – by defining it as the residents of a specific geographic unit of the city, along with assorted building owners, business operators and others who have a stake in the area. Their representation depends on who shows up for a meeting. This resolution was the result of a political struggle between police and politicians, on one side, and a fragmented collection of community organizations on the other, played out during the early years of the program. The organizations "outside" wanted "inside." They demanded that the meetings

be organized and led by local groups that would control the agenda and invite police to participate on their terms. They wanted civilian involvement in all significant aspects of the program to be directed by leaders who were either elected by beat residents or who somehow emerged from locally prominent organizations. These organizations had an agenda that extended further than crime. They saw resident involvement in CAPS as another vehicle for building the autonomous capacity of residents to help themselves and lobby effectively in the corridors of power for the outside resources needed to address their most pressing problems. Because all of this would take time and energy, they also wanted grants and contracts to support the professional organizers required to carry off this vision of resident involvement.

Police and city leaders would have none of this. Politicians were worried that beat community meetings would provide a venue they could not control – one where complaints about elected officials and efforts to unseat them might be initiated. In this post-political-machine era, none of the aldermen had a mechanism for reaching the grass roots in their constituencies that approached the magnitude of what the police were proposing to create. Police feared that the meetings would be taken over by “loud mouths” who would vent their spleen given any uncontrolled opportunity, and by people who would try to bend police priorities to suit their personal interests. Officers felt that they could not be “the friend of the people” (as one put it) and enforce the law against them at the same time. The department insisted on being the official “host” for the meetings and on controlling the agenda. This was a one-sided struggle, for the mayor, the city council and the police held all the power. Looking back later in disappointment, the leader of the community empowerment side of this battle lamented:

It could have been a community-building and empowering process; could have developed a democratic partnership with police; could have involved tens of thousands in ongoing cooperative problem solving. The implications of its potential frightened the city, and so the administration gave us what we have now – a program that, measured against what it could have been, is clearly a failure.

Chicago proceeded with a “de-politicized” version of representation at beat community meetings, because that was the politically safe route. But that decision raised hard questions. Unlike formally constituted bodies – made up, for example, of heads of organizations, official nominees of the mayor or elected representatives – beat community meetings are composed of those who happen to hear about them and choose to attend. Between the point when they began to meet citywide in 1995 and June 2002, Chicagoans attended beat community meetings 488,000 times. However, on a monthly basis this constitutes only a small percentage of beat residents. In many areas a good meeting draws about 30 residents, which averages only about 0.4 percent of the adult population of a beat.⁴ So while sheer numbers were important, it was also important

⁴ By contrast, in the average beat about 28 percent of age-eligible residents turned out for the 1995 mayoral general election.

that beat community meetings represent the interests of residents. Even a small meeting can do this effectively if those who attend adequately articulate the concerns of the general public. This raises representational questions about beat community meetings.

One issue is, to what extent do those who attended beat community meetings resemble community residents? The answer involves comparisons like those made in Figure 13. It describes the relationship between the demographic composition of the beats (at the bottom of each chart) and the background of those who attended meetings there (on the side of each chart). Information about beat residents is based on the 2000 census. The contrasting data on beat community meeting participants is drawn from questionnaires completed by 3,656 residents who attended meetings in 124 beats for which there is complete data for this analysis.

Figure 13
Neighborhood Representation at Beat Community Meetings

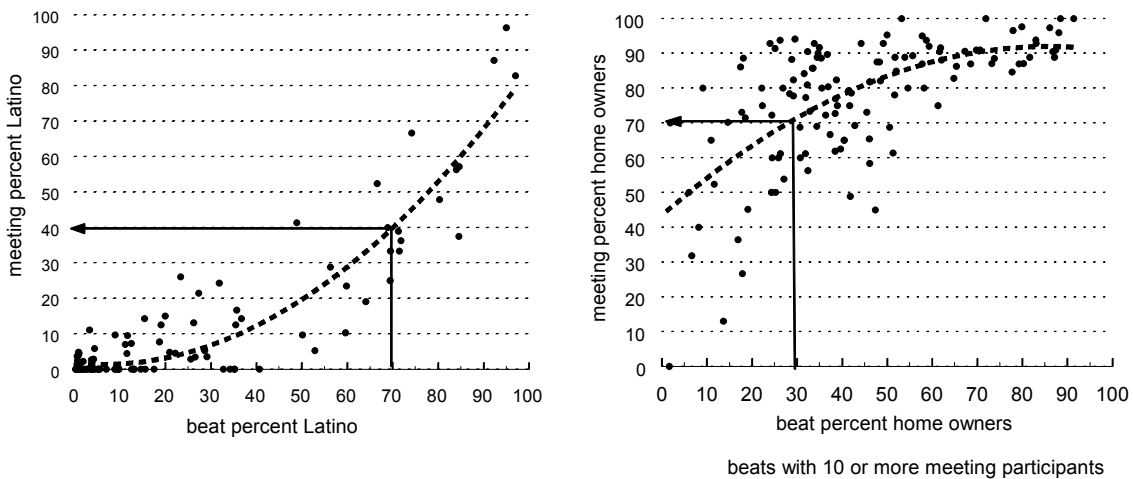

The right panel in Figure 13 depicts the match between the percentage of beat residents and meeting participants who owned their home, an important feature of any neighborhood. As it indicates, home owners were significantly overrepresented in the beats we observed: they were the majority group at 90 percent of the meetings. At the average meeting, 77 percent of participants were home owners, compared to a beat average of 44 percent. The overrepresentation of home owners is especially apparent at low levels of beat home ownership; this is signaled by the decelerating regression line that is the best statistical description of the relationship between the two measures. As the arrows in Figure 13 illustrate, beats that averaged about 30 percent home owners were represented by meetings where about 70 percent of the participants were home owners.

The left panel of Figure 13 charts the representation of the city's Latinos. It documents that Latino participation in beat community meetings tended to be low except in beats where a

“critical mass” of Latinos resided. There it rose sharply, as illustrated by the rapidly accelerating regression line. But there were relatively few concentrated Latino beats in the city above the “take-off” point (only 15 beats in the study sample were at least 70 percent Latino), so gross underrepresentation of Latinos was the norm. Even at the 70 percent Latino mark, the proportion of Latinos at beat community meetings was generally only about 40 percent.

Beat community meetings overrepresented other groups as well. Older neighborhood residents were also overrepresented. In beats where about 15 percent of the population is over age 65, almost 30 percent of those attending meetings were senior citizens.

In short, on many dimensions, involvement in Chicago’s beat community meetings demonstrates an “establishment bias.” This is not uncommon: in many social programs that rely on volunteers, better-off and more established members of the community are the quickest to get involved and take advantage of the effort. Research on involvement in neighborhood anti-crime organizations find that higher-income, more educated, home owning and long-term area residents more frequently know of opportunities to participate and are more likely to get involved when they have the opportunity. In the case of beat community meetings, the largest discrepancies in involvement favored home owners, non-Latinos and older, long-term residents. It is important to underscore, however, that this overrepresentation took place within beats. It was not better-off people from some other neighborhood who took fullest advantage of the program, it was the neighbors of those who did not. In poor areas they were scarcely an “elite” ; they were just a little better off, and they might still do a good job representing the interests of their small area of the city.

Latinos were the most underrepresented racial or ethnic group. Chicago has made efforts to involve Latinos more deeply in its community policing effort. The publicity campaign supporting the program featured a component aimed at Spanish-speaking residents. It has included paid promotional announcements and a police-staffed talk show on Spanish-language radio; booths at festivals held in Latino neighborhoods; and wide distribution of posters, flyers and newsletters in Spanish. Spanish-speaking community organizers work for the city to generate involvement in beat community meetings and in problem solving. The city’s emergency communication system is staffed to handle foreign-language calls, and the police department itself has about 800 Spanish-speaking officers. The department’s cadet diversity training includes some role-playing exercises revolving around linguistic issues. But despite these plans, the integration of the city’s Latino residents into CAPS has proven difficult to accomplish. As we noted earlier, English-only handouts were available at 83 percent of the meetings, and only 4 percent of the meetings we attended featured even a little translation.

It is also significant that there has been little progress in improving the representativeness of Chicago’s beat community meetings. The patterns of participation revealed by the 2002 beat community meeting study paralleled almost exactly the findings of our 1998 study, which were presented in our November 2000 report. In 1998, beat community meetings also overrepresented home owners, long-term residents and older Chicagoans, and dramatically underrepresented the city’s growing Latino population.

Solving Neighborhood Problems

During the summer of 2002, the CAPS evaluation team conducted a study examining how Chicago police tackle neighborhood problems. The study focused on the problems that are most often identified by the police as local priorities. Interviews, field observations and archival data were examined to a) reconstruct what actions police and residents took at each site, and b) assess the success of their problem-solving efforts. A final section examines the relationship between the actions that were taken at each site and what happened as a result.

Problem solving is one of the key components of CAPS. In Chicago, a “problem” is defined as a group of related incidents or an ongoing situation that concerns a significant portion of those who live or work in a particular area. Links between incidents can arise from common victims, offenders or methods of operation, but most are defined by their concentration in specific locations. Problems are also persistent: they are unlikely to disappear without an intervention of some significance, because they typically have survived routine efforts of the police to resolve them. Because they are persistent, repeated incidents probably share causes, so dealing with these underlying sources may prevent future problems. It is also important that problems potentially can be solved using the resources that police and the community can bring to bear on them; they cannot take on society’s largest problems at the beat level. Finally, while dealing with crime remains at the heart of the police mission, problems can include a broad range of community concerns. They range from noise to the dilapidated condition of many of the city’s older rental buildings, and include a host of social disorders, municipal service shortcomings and a broad range of code enforcement matters.

Police and thousands of neighborhood residents have been trained to respond to local problems using a five-step process. The first step is to **identify** problems and prioritize them. Next, officers and residents are to **analyze** problems following the “crime triangle.” The process calls for them to gather information about offenders, victims and locations of crimes. Subsequently, they are to **design strategies** that might deal with the chronic character of priority problems. They are asked to “think outside the box” of traditional police enforcement tactics and to use new tools that have been developed to support their problem-solving efforts. Chicago’s model also recognizes a stage during which the community, police and other city departments **implement** strategies. This highlights the special skill and effort required to actually set plans in motion. Finally, police and residents are to **evaluate** their own effectiveness by assessing how well they carried out their plan and how much good they accomplished. Between 1995 and 1997, most patrol officers and more than 12,000 civilians were taught this process. The department’s information technology (which is described in a later section of this report) can be a help at several stages of the problem-solving process, and city services can be mobilized to deal with a broad range of environmental conditions.

As part of its commitment to the “grass-roots” planning process that was described in some detail in a previous section of this report, major responsibility for identifying priority problems rests with the city’s 279 beat teams. They are to identify two to three local priorities based on their experience, analysis of crime data and discussions with residents at beat community meetings. These priorities are set under the direction of their sergeant, who prepares

a beat plan form that describes each problem and the strategies they plan to use against it. The district's CAPS lieutenant must approve each plan, and must later approve closing it when the problem has been abated. These plans provide major input into the crafting of district and area level plans, so senior managers in the district also review them on a regular basis.

Figure 14
Problem-Solving Study Sample

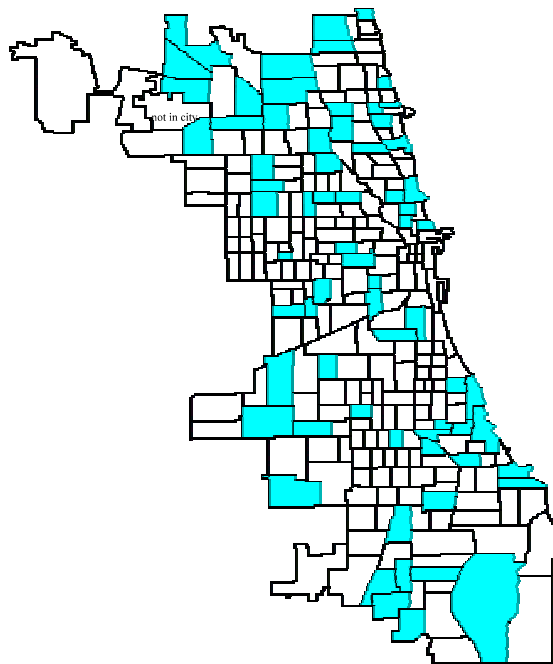

The Problem-Solving Study⁵

To begin this study, a database was constructed that included all of the department's beat plans initiated between July 2000 and July 2001. The most common problems that beats identified were chosen for examination. They included:

Drugs and Gangs. Very few beat plans identified one of these issues without implicating the other, and just one gang-only problem appeared in the sample. The 21 study sites in this group included those prioritizing street drug markets, drug houses, gang involvement in drug sales, and gang violence.

Property Crime. Specific crimes in the study sample include house and garage burglary, shoplifting, break-ins of autos and auto theft. Twenty-five beats identifying property crime priorities were selected for the study.

Social Disorder. Sample problems in this category include public drinking, noise, prostitution, teenage disturbances, issues caused by irresponsible liquor establishments, disruption around schools, gambling and homelessness. Twenty-two beats were working on problems in this category.

Only plans in effect for at least a year were included in the sample to ensure that police and residents had time to mount a serious problem-solving effort. While beats typically have more than one plan in effect at any given time (most have two or three active plans), a beat could be selected for inclusion in the study only once. Only beats with problems falling into the categories described above were selected. After these criteria were applied, beats were selected at random for the study. Figure 14 describes the location of the beats; the study was conducted in all but three police districts, one of which encompasses the central business district.

⁵A detailed description of the 2002 problem-solving study is found at the Institute for Policy Research Web site (www.Northwestern.edu/IPR/publications/policing.html). It includes copies of all forms and interviews used in the study.

To carry out the project, field observers were trained to conduct systematic observations of problem sites. Six pairs of observers were in the field between May and September 2002. They began with the geographical description of the problem site that was noted in the beat plan, and the plan's explanation of the nature of the problem itself, but these were usually quickly amended as they made observations and interviewed local informants.

One of the observers' tasks was to make an assessment of conditions in the problem area. Each time they visited a beat they completed a site assessment form that recorded problematic behaviors by people visible on the street. They counted youths and adults who were loitering in groups and those they suspected of drug dealing. They watched for public drinking, soliciting for prostitution, panhandling, gambling and apparently homeless or mentally ill people. They also recorded the extent of graffiti, trash, abandoned cars and discarded liquor or beer bottles. Except for those related to property crime, their observations gave us an independent measure of the visibility of priority problems to trained observers. A total of 424 site assessments were completed in the 68 study beats.

A most important task of the observers was to identify and interview knowledgeable informants. The observers conducted personal interviews with police officers whom they identified as knowledgeable about the problem site. Of the 142 officers interviewed, 87 percent were members of the beat team or the beat sergeant, 6 percent were members of special gang or burglary units, and 5 percent worked for the district Community Policing Office. The officers had served in the beat or district for an average of 4.6 years. They were questioned about the nature of the problem; what they had done about it; what other department units had done about it; the efforts of community groups and city agencies; and how successful efforts to solve the problem had been.

Observers also interviewed neighborhood residents and others who were knowledgeable about the sample problem. They identified the residents by attending beat community meetings in the area; contacting community organizations and members of District Advisory Committees; interviewing members of the district Community Policing Office; and riding with beat officers. They interviewed 138 knowledgeable residents. The respondents had lived or worked in the beat for an average of 18 years, and 75 percent had a formal role in CAPS. Just over 50 percent reported that they had been trained during the mid-1990s, when problem-solving courses were held throughout the city, and 82 percent indicated that they had discussed the sample problem with a police officer. Like the police, residents were questioned about the nature of the problem; what they had done about it; what community groups and city agencies had done; what they knew the police had done; and how successful efforts to solve the problem had been.

In addition to answering more conversational questions, both police and residents completed systematic rating sheets. One section asked them to rate the frequency of either police or resident activities, and the other asked them to rate progress against the problem on a number of dimensions. After completing work on a problem site, the observers completed their own rating sheet assessing the extent to which problems were solved. In each case, the questions focused on the sample problem we were tracking in the beat. A total of 135 observer rating forms were completed.

The fieldwork component of the evaluation was supplemented by statistical analyses of quantitative time series data on crime and calls for service. They provide an alternative view of conditions at the site and have the advantage of extending back in time.

Problem-Solving Strategies. The first question is, what did police and residents do about problems on their beat? To examine this, we relied on the results of personal interviews and rating sheets completed by police and residents. Coders carefully examined the text of the interviews and classified all of the problem-solving activities reported in each. Because they each had different experiences upon which to draw, police and residents we interviewed were asked to describe actions undertaken by both police and residents. Not surprisingly, police knew more about police efforts, and community members knew more about community activities, but each had things to share about the other. The data presented here combine the information provided by all of the parties. Taking advantage of the fact that we have multiple informants for each problem site, only strategies that were described by at least two of them are included, for we have more confidence when informants agree about what was happening in their beat.

Table 3 summarizes the frequency with which various strategies were described for each type of problem. For example, at least two police and/or residents reported that foot or bike patrols were deployed in 19 percent of gang and drug sites, and community marches or patrols took place in 29 percent of those areas.

The police officers and residents who were interviewed described a variety of police problem-solving efforts in their beats. As summarized in Table 3, the most common police strategy was high-visibility patrol, which was frequently employed in response to all kinds of problems. This category included directed patrol, rapid 911 response, special mission cars and other efforts to establish a police presence in an area. Overall (total figures are not reported in Table 3), these tactics were utilized in 87 percent of the study areas. Foot or bicycle patrols were used fairly infrequently, at less than 20 percent of the sites. Aggressive stops listed in Table 3 included intensive traffic stops and traffic enforcement; warrant, name and license checks; field interrogations; more intensive use of administrative violation notices; undercover “buy-bust” operations; and issuance of dispersal orders under the city’s gang and drug loitering ordinance. Overall, these tactics were employed in 38 percent of the priority problem sites. The special units that are identified in Table 3 include narcotics units (which were most frequently named), gang teams and the vice squad (for prostitution problems).

Nontraditional policing strategies were also described fairly often, particularly for property crime, but also in half of the social disorder sites. In this category it was very common to hear about prevention awareness programs run by police officers, especially for property

Table 3
Police and Resident Problem-Solving Strategies, by Type of Problem

Percent of Beats Employing Each Strategy							
police strategies	beats having problems with			agency and community strategies	beats having problems with		
	drugs and gangs	property crime	social disorder		drugs and gangs	property crime	social disorder
police surveillance	29	4	9	community organizing	57	32	23
high-visibility police patrols	100	76	86	community marching or patrolling	29	4	14
foot or bike patrol	19	16	23	community clean-ups	5	4	0
aggressive police stops	43	24	50	community education strategies	14	44	14
more police arrests or citations	91	24	77	community provides services	5	0	9
involve special police units	52	32	32	CAPS Implementation Office involved	62	48	54
non-traditional police responses	38	76	50	city service agencies involved	76	64	50

Note: cells report the percentage of beats in each problem category in which two or more police and/or residents described the strategy being employed. There are 21 gang and drug sites, 25 property crime sites and 22 social disorder sites. Data are based on the responses of 138 residents and 142 police officers.

crimes such as burglary and theft from autos. Thefts from autos in particular are encouraged by victim carelessness, and this was the target of a number of leafleting campaigns. Property crime problems also attracted projects to involve businesses in preventing crime, distributing posters and flyers, and using the department’s information technology to examine crime patterns. Street roll calls were conducted in gang and drug areas, and police there were described as working closely with beat meeting participants, talking with residents, and using code enforcement and other tools to attack the problem. Beat meeting participants and businesses were also vehicles for police efforts against social disorders, as were public awareness programs.

Everyone who was interviewed was also asked about community involvement in the problem. Block club organizing and community marches and patrols were frequently undertaken at drug and gang sites. Like on the police side, educational campaigns of a variety of types were very commonly described by informants in property crime areas. Overall, educational campaigns were conducted in 38 percent of the study areas. Community organizing, patrols, “positive loitering” campaigns, programs with businesses, and educational campaigns were the most frequent community efforts against social disorder.

City agencies were also frequently involved in problem solving; overall, they were described as contributing to solving problems in 63 percent of beats. The Department of Streets and Sanitation and its Forestry Bureau predominated, for the bulk of the services that were described involved street lighting projects, clean-ups, tree and bush trimming, car tows, graffiti removal and sidewalk repairs. We also asked our informants whether the city's CAPS Implementation Office was involved in solving the problem. This office is involved in both mobilizing residents for marches, vigils and beat meetings, and in organizing coordinated city service projects in blighted areas. Overall, representatives from the CAPS Implementation Office were a visible presence in almost 55 percent of the problem sites.

Rating sheets completed by police and residents add an additional piece of information about their problem-solving strategies – the extent or frequency with which they are employed. To assess this, police officers were presented with a list of 11 common patrol strategies and asked how frequently they did them in a typical week. Their responses could range from zero (they did not do them at all in a typical week) to five (they did them virtually every day). Residents were asked to report on the frequency of a list of 11 community strategies. As was not the case with the strategies list, each group described only its own efforts. In both cases, the questions reminded respondents of the date on which the problem was officially prioritized, and the questions referred to efforts since that time. Table 4 presents the results; for the police it presents the average frequency for each strategy, while in the community column it notes the percentage of strategies that were initiated more than once.

On the police side the most frequent activities are found at the top of Table 4, which summarizes a list of traditional enforcement activities that form a statistical cluster. Visible patrol, confronting troublemakers and conducting field interrogations were the most frequent. The average for all of these enforcement activities is presented at the bottom of the policing column. On average, officers engaged in these activities more than three times a week in gang and drug areas, and somewhat less in the other sites. More nontraditional policing tactics are described at the lower left. Gathering information through interviews and the department's data systems was fairly common for drug and property crime sites, but otherwise activities on this list were carried out only about twice a week.

In the resident column there is a great deal of variation in the use of strategies. The group of strategies at the top of the resident column formed one statistical cluster, and in combination they reflect a broad range of efforts to actively organize and involve the community. Involving beat community meeting participants and block clubs in solving a problem, and mobilizing to confront problems with liquor outlets were the most frequent of these. School-based projects were the least common in each problem category. Two strategies in the middle of that column formed another statistical cluster; they both reflect using government to solve problems, by involving aldermen and using the district court advocacy committees to bring local priorities to the attention of the court. Both of these strategies were reportedly common in each problem-site category.

Table 4
Police and Resident Problem-Solving Activity, by Type of Problem

Average Beat Activity Levels							
police strategies (average number of times they do it in a typical week)	beats having problems with			community strategies (happened more than once since problem was identified)	beats having problems with		
	drugs and gangs	property crime	social disorder		drugs and gangs	property crime	social disorder
Answer a call in this area that is related to the problem	3.0	2.1	1.8	Hold a march, vigil or smoke-out at the location	47	23	37
Drive through this area to establish a police presence	4.6	4.9	3.4	Organize a “positive loitering” campaign	43	30	36
Confront a troublemaker who is part of the problem	3.2	2.0	2.5	Form a neighborhood watch group or a resident patrol	47	50	33
Do a traffic stop and contact card related to the problem	2.6	2.0	1.9	Involve block clubs or local organizations	69	70	59
Make a foot stop and field interrogation related to the problem	3.0	2.4	2.4	Get local businesses and liquor stores to cooperate in a campaign against it	59	42	46
Enforce a city ordinance, curfew or truancy law, or use an ANOV to get at this problem	2.4	1.8	1.9	Organize a parent patrol or “walking school bus” at a local school	23	18	28
Get information from a resident about the problem	2.6	2.4	1.7	Involve people from the CAPS beat community meeting	90	76	82
Use CHRIS or ICAM to examine data about the problem	2.3	2.5	1.4	Involve the alderman’s office against it	79	70	59
Check a mug shot or Rogues Gallery to help look for someone associated with the problem	1.9	1.6	1.2	Use the CAPS court advocacy group in a court case against it	48	46	64
Contact a city agency or use a service request form to get action on the problem	1.6	1.2	0.9	Hold a neighborhood clean-up or fix-up project	58	65	53
Talk to a landlord, building manager or shop owner to get action on the problem	2.0	1.9	1.1	Put up posters or hand out information about the problem	68	85	38
avg. traditional (top)	3.3	2.5	2.7	avg. activism (top)	59	52	55
avg. nontraditional (bottom)	2.2	1.9	1.3	avg. use of city (middle)	64	58	62

Note: cells report activity levels in beats in each problem category. For police it is the average number of times per week they report doing it; for residents it is the percentage of beats in which they are aware that it has occurred more than once.

Measuring Success in Problem Solving

For the purposes of this study, measuring the success of problem-solving efforts was done in two ways. First, personal interviews with neighborhood residents and police included questions about the problems and what had happened since they were identified as priorities by the police. Rating sheets completed as part of the interview by both police and residents also included questions about the problem. The number of interviews conducted in each beat was small, but respondents were chosen for their knowledge and experience, as well as for their ability to provide an overview of the problem at hand. Of course, police and residents brought different experiences to the interviews and viewed local problems from somewhat different perspectives, but that was another strength of using both groups to assess progress in problem solving. At the end of their explorations of each problem beat, our observers also made their own assessments of what had happened there. We found that, while they were observing neighborhood conditions from different vantage points, there was broad agreement between police, residents and our observers on where they had been more successful and where they had been less successful in terms of their problem-solving efforts. The comments police and residents made during their personal interviews also agreed with the results of the rating questions, once the former were extracted and coded from transcripts of the interviews.

The interviews also enabled us to gauge trends in a broad range of outcomes. We were not interested solely in how much crime there was, but also in the ways in which it affected the community; whether the community organized to fight back; and whether they worked in collaboration with the police to do so. Increasing community organization and resident involvement is known as a problem-solving “process success,” and these are not things that can be measured by crime statistics alone.

We also used data from the police department’s 911 center and crime reports filed by officers responding to the calls. There were many advantages to using them – most importantly, they extend backward in time. We used 78 months of crime data and 40 months of 911 calls to contrast “before and after” levels of crime in the study beats. As described below, we also compared targeted beats with similar areas that did not have the same priorities to see if trends differed in areas where our study problems were prioritized. This was important because crime rates have been dropping in Chicago for the past decade. As a result, the fact that they went down in a beat over time is not alone strong evidence that problem solving made a difference there.

Interview success ratings. During their in-person interviews, beat officers and neighborhood residents who were questioned completed an assessment form that asked them to rate their progress on the problem since the date the problem was officially designated a beat priority. They responded along seven-point rating scales that ranged from “much worse” to “much better, with a “4” at the midpoint indicating that the situation had remained “about the same.” At the completion of all of their investigations, our observers also completed their own assessment forms, drawing upon everything they had learned from their personal site inspections and observations, the interviews, their review of beat plans and their observations of beat community meetings. The average beat was rated by six informants and observers.

We combined these ratings to produce beat level measures because of the raters' broad agreement about what was occurring in their beats. For example, the average correlation between police and resident ratings of trends in the "impact of the problem on area families" was +.32, and +.45 between observer and resident ratings and +.29 between observer and officer ratings. A summary rating was created by adding each beat's three sets of ratings. The summary score was correlated above +.70 with each of the three individual ratings. The correlation between resident and officer reports on problem trends in personal interviews was +.38.

Combining the ratings supplied by all of the observers for a beat produced summary survey measures of progress in problem solving along several important dimensions. These are summarized in Table 5. One dimension is the apparent **frequency** of the problem, which was indexed by responses to questions about trends in the number of people involved in causing it and about its magnitude (the questions asked about the quantity of drugs sold, the amount of property stolen and the size of the area affected, depending on the problem type). Overall, informants from 65 percent of the study areas saw a reduction in the number of people involved, and 49 percent saw a decrease in the magnitude of the problem. They saw their biggest success in reducing the frequency of social disorder.

Another outcome dimension is the **consequences** of the problem. This was measured by responses to questions about trends in public concern about the problem, its visibility, its impact on area families and innocent passers-by, and the extent to which it generated other kinds of crime. Overall, our informants saw improvements in the visibility of the problem in 90 percent of the beats, but in less than half of the beats were they optimistic about the impact of problem solving on other crimes generated by the problem they were working on. Everyone was least optimistic about alleviating the consequences of drug and gang problems for the community.

In line with the CAPS vision of problem solving, increased resident **involvement** in solving problems through their own actions and in cooperation with the police were also included among the outcome measures. Overall, residents of about half the study beats were reported to have enhanced capacity to work on their own to solve problems, and the biggest success registered in this category was in resident cooperation with police in solving social disorder problems. Finally, the assessment inventory included a question about trends in resident **satisfaction** with police efforts. Our informants thought that satisfaction grew most in property crime and social disorder sites.

The bottom of Table 5 includes two summary rating measures that were formed by statistically clustering the outcome ratings. They provide general measures of success in solving the problem, and in "process successes" in the form of resident involvement and satisfaction. In each case, the percentage of our informants averaging a positive trend – for example, fewer people involved in a problem or increased satisfaction with the police – is presented. By these summary measures, our informants – the police, neighborhood residents and the observers – were least sanguine about solving drug and gang problems, and most optimistic about dealing with social disorder issues.

Table 5
Survey Measures of Problem-Solving Success, by Type of Problem

	Percent Averaging an Improvement			
	drugs and gangs	property crime	social disorder	all sites
Problem Trend				
- problem has “gotten better”	81	88	82	84
Problem Frequency				
- number of people causing it	62	60	73	65
- magnitude of the problem	33	60	50	49
Problem Consequences				
- resident concern about problem	67	72	68	69
- visibility of the problem	81	92	95	90
- impact on area families	33	60	68	54
- impact on passers-by	52	—	77	65
- other crime generated by it	33	—	59	46
Resident Involvement				
- efforts to act on their own	38	60	55	51
- cooperation with police efforts	62	60	68	63
Satisfaction with Police Efforts				
- resident satisfaction with effort	52	76	73	68
average frequency and consequences	43	64	68	59
average involvement and satisfaction	52	60	68	60

Note: “—” indicates the question is not relevant for the problem type.

Trends in crime data. The fieldwork component of site assessments was supplemented by statistical analyses of quantitative time series data on crime and 911 calls. Time series trends in appropriate categories of calls for service and recorded crime data were created for each problem site. For example, if the beat priority was house burglary, the crime trend data included only burglaries of residential dwellings, and the process was similar for auto theft and other crimes. These indicators were selected to provide a view of the life course and fate (as of mid-2002) of each sample problem over time. They provided an alternate view of conditions at the site, with the advantage of extending back in time and casting a wide net over conditions there.

Comparable time series data were assembled for matched sets of beats in which the sample problem was not identified as a priority. Comparability in this instance meant that the beats fell in the same race-class-lifestyle cluster of city beats, of which there are six. These trends provide a general baseline for each problem beat and serve as a control series for each problem we selected for study. For example, a decrease in crime in a study beat – but not in its matched comparison areas – suggests that police might have been successful there. Likewise, if crime rose in a set of comparison areas but remained stable in the matched problem-solving beat, that stability may also have been a result of police efforts. The comparison series included

multiple beats. For example, each comparison-group series for a drug-problem site included data from an average of nine beats that were similar to the study beat, and for property-crime beats the average was 32 beats. We did this to smooth out the impact of unusual events or conditions in comparison areas and to provide a general background against which to assess trends in the study beats. However, it must be noted that similar beats that do not face similar problems must differ on other unmeasured factors, and this aspect of the research design is far from a controlled experiment. Also, it was not always possible to identify comparison series. In the case of drug crime, it turned out that every beat located in poor, predominately African-American areas had prioritized a drug problem of some sort, so there were no control areas to be found.

Crime data were aggregated from information on 3.9 million individual crime incidents that were reported during the 78 months between January 1996 and June 2002. On average, there were data for 66 months before a problem was prioritized and 22 months afterward. The data are monthly counts of relevant incidents for the target beats and matched sets of comparison beats. The advantage of these data is that they detail what the police determined actually happened at the scene. In this study, recorded crime data are best for assessing the effects of police efforts against violence and property crime. The burglary series includes forcible, unlawful and attempted burglaries of homes and residential garages. The motor vehicle theft series includes both attempted and completed crimes. Theft from auto cases are inadequately measured by the police, for they frequently fail to enter the detailed information needed to classify them when filling out their reports, so we cannot examine trends in those problem sites in any detail. Recorded crime data are not very useful for examining drug problems. In general, a crime incident is recorded in this category only when a drug-related arrest is made. As a result, there is no real distinction between the apparent extent of crime and police success in catching someone. However, drug problems are often associated with assaultive violence, and these are better measured by the police. The recorded crime data examined here include both attempted and completed assaults and batteries. Crime reports are also not very useful for examining many of the social disorders in our study, for they often do not generate a standard offense report. For drug and social disorder problems, we rely more heavily on citizen complaints registered through the city's 911 system.

The 911 data were aggregated from 23.4 million calls to the City of Chicago's Office of Emergency Management and Communications using the same design. An advantage of these data is that they are gathered independently of the activities of responding officers, who may choose to reclassify or discount incidents. However, 911 data also provide only a very rough guide to what took place at the scene. The city's Office of Emergency Management and Communications gathers only data required to make a dispatching decision, and what actually happened at the scene is usually best assessed by the responding officers. For drugs, we included calls classified as complaints about narcotics selling, narcotics loitering, and gang and narcotics loitering. For prostitution problem sites we used the call classification "vice complaints." The calls-for-service data are for 40 months – January 1999 through April 2002 – so the time series is also short for statistical purposes. On average, there were data for 19 months before a problem was prioritized, and for 21 months afterward.

Where these data were available, the goal was to use them to provide another indicator of beat problem-solving success. Two measures of success are presented here. The first is whether crime went down. This involved a simple comparison of levels of crime targeted by beat officers, before and after they identified a problem as a priority. However, as noted above, this is not a very strong test of problem-solving effectiveness. As we have seen, crime in Chicago was in general decline during the 1990s, and the offense rate could easily have gone down in a particular beat for other reasons, even if a problem was not specifically targeted. Alternately, a stable level of crime might be evidence of police success if factors in similar areas were causing crime rates there to move up at the same time. The second measure of success takes these possibilities into account. It is based on the results of a complex statistical analysis of trends in both the study beats and their matched comparison areas. A Box-Jenkins Intervention Analysis was conducted of each time series. It distinguishes between gradual and immediate changes in crime, whether those changes were – through June 2002 – temporary or permanent in nature, and whether trends in the study beats were unique or just matched trends in similar areas of the city.⁶

To illustrate all of this, Figure 15 presents data for a study beat on Chicago’s North Side. It plots trends in the beat’s priority problem – house burglary – for 19 quarters (57 months) before that problem was identified, and for five quarters (15 months) after it was prioritized. The point at which the beat plan was filed (January 2001) is also identified in the figure. Figure 15 depicts quarterly data, but all of the statistical analyses described above used monthly crime counts. The quarterly data still “jump around” considerably in response to the weather and other factors, so actual figures are presented in the faint background in the figure. Readers should pay more attention to the general trend revealed by the data. This is depicted by dark dashed lines, one for the months before the beat plan was filed and another for the months afterward. These lines document that the number of offenses was increasing during the months leading up to the decision by the beat team to prioritize house burglary. After, the trend shifted markedly, heading in a downward direction. A simple comparison of the average levels of house burglary before and after the beat plan was filed would indicate that crime was down in this area.

Figure 15 also introduces data from this beat’s comparison areas. Another dark line illustrates house burglary trends in 17 other similar beats; this trend is labeled “comparison beats” in the figure. Only the trend line is presented; quarterly data are not. The comparison beats provide a baseline indicating how trends in the study beat might have looked in the absence of an intervention by beat officers. Unlike in the study beat, house burglary in other areas declined during the period before 2001. The key point, however, is that it turned upward through the middle of 2002, when the data come to an end, while house burglary began to fall in the study area. This suggests that social forces generally affecting these kinds of city neighborhoods were causing crime to rise, at a time when it was falling in our study area. A statistical analysis of these data confirmed the conclusions suggested by the figure: in the months immediately following the intervention, house burglary increased unexpectedly in matched areas but declined sharply in the study beat, which is what we would expect based on past trends.

⁶A detailed report on the statistical analysis of time series data for the 2002 problem-solving study can be found at the Institute for Policy Research Web site (www.Northwestern.edu/IPR/publications/policing.html).

Figure 15
Time Series Analysis Example

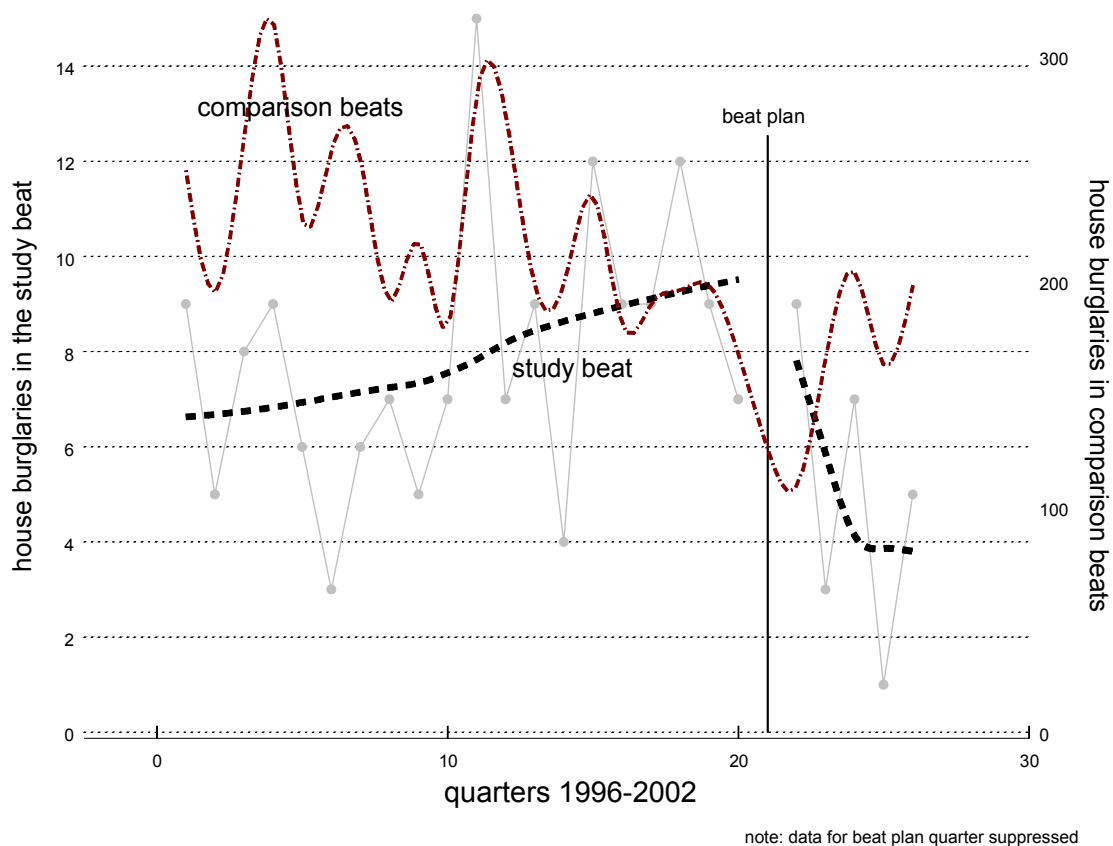

Table 6 summarizes trends in the crime and 911-call data for all of the study beats. The top sections of the table report whether or not crime was down significantly. Overall, recorded crime was down in 52 percent of the beats. It was down much more often in property crime areas (81 percent) than in the drug problem areas that we examined (24 percent). The beat described in the example above was in the former category. Trends in 911 calls point to fewer successes, however. In the case of drugs, only 12 percent of beats registered a statistically significant decline in complaints by the public, and for social disorder the success rate was zero. In both categories the most frequent situation was that there was no change in the volume of citizen complaints in the months following the prioritization of these problems.

The lower section of Table 6 presents a more detailed picture of trends in the study beats and their comparison areas. Nine possible configurations could occur, but only three were consistent with problem-solving success; they are presented separately in Table 6. The example presented above of the beat with a priority house burglary problem is included among the “priority beat down and comparison up” cases, for that was the statistically significant pattern.

Table 6
Analyses of Recorded Crime Trends, by Type of Problem

	Trends in Recorded Crime			Trends in 911 Calls		
	total	assaultive violence	property crime	total	drug complaints	social disorder complaints
percent of study beats where crime was:						
down**	52	24	81	8	12	0
unchanged	39	59	19	76	75	78
up	9	18	0	16	12	22
percent of beat pairs						
study beat down and comparison up**	25	18	31	20	31	0
study beat down and comparison stable**	16	12	19	16	12	22
study beat stable and comparison up**	3	6	0	16	25	0
other patterns that indicate no effect	56	64	50	48	32	78
number of beat pairs	33	17	16	25	16	9

** statistically significant pattern consistent with problem-solving effectiveness

Based on recorded crime trends, one-quarter of the study beats fell in this category, and another 20 percent in other patterns that were consistent with successful problem solving. On the other hand, a majority (56 percent) did not point to any success at all. Overall, the analysis of 911 calls pointed to more frequent successes than did the analysis of recorded crime. This was especially the case in the drug category, compared to social disorder problems.

Problem-Solving Efforts and Successes

The final question is, what is the relationship between what police and residents did and the outcomes they achieved? To examine this, we merged the results of the analyses presented above. Measures of problem-solving strategies and activity levels of police and residents (summarized in Tables 3 and 4), as well as the outcomes reported by them and our observers (summarized in Tables 5 and 6), were compared with outcomes reported by police, residents and our observers. The outcome measures are the two summary indicators presented in Table 6: problem frequency and consequences, and resident involvement and satisfaction. Table 7 presents the findings in the form of correlations between selected strategy and activity measures and the two outcome indicators. They indicate when strategies or activities corresponded with the outcomes in a substantial way. Blank spaces indicate that there is no correlation.

Table 7
 Problem-Solving Strategies and Outcomes, by Type of Problem

Selected Correlations Between Strategies and Outcomes				
	drugs and gangs	property crime	social disorder	all sites
Impact on Frequency and Consequences				
traditional enforcement strategies				
nontraditional police strategies			.45	.27
traditional enforcement activity level				
nontraditional police activity level		.25		
<hr style="border-top: 1px dotted black;"/>				
community activism	.54			
community education strategies		.59		.28
using government strategies	.30		.27	
Implementation Office involvement	.26			
Impact on Involvement and Satisfaction				
traditional enforcement strategies				
nontraditional police strategies	.62			.34
traditional enforcement activity level				
nontraditional police activity level	.43	.32		
<hr style="border-top: 1px dotted black;"/>				
community activism	.48			
community education strategies		.47		.34
using government strategies			.44	
Implementation Office involvement	.44			
Impact on Time Series Measures				
traditional enforcement strategies		.37	.36	
nontraditional police strategies				
traditional enforcement activity level		.34	.39	
nontraditional police activity level		.49	.29	.32
<hr style="border-top: 1px dotted black;"/>				
community activism	.44	.51		.36
community education strategies		.37		.32
using government strategies				
Implementation Office involvement			.81	

One column in Table 7 reviews factors associated with positive outcomes in drug and gang sites. There, community activism and non-traditional police strategies and activities were associated with improving neighborhood conditions. So, too, was the involvement of the CAPS Implementation Office in gang and drug projects. In the case of property crime, educational strategies and nontraditional police activity levels (which involved information gathering, using city services and dealing with building managers) were linked to outcome and process successes. Community activism and educational strategies were linked to reductions in recorded crime, as were both traditional and nontraditional policing strategies. For social disorder, both traditional and nontraditional policing were linked to declines in citizen complaints via 911, as were efforts by the CAPS Implementation Office and using the help of government agencies more generally. In general, community strategies and activities, as well as nontraditional policing, were more consistently related to improving local conditions than were conventional policing efforts.

Of course, there are many reasons not to interpret any of these associations as causal. The sample sizes are small, particularly for the columns that present results separately for the three major problem categories, so the results could be due to chance factors. While we gathered detailed descriptions of the strategies and activities examined here, they have been combined at a fairly abstract level into the analytic categories described above, in order to discover broad patterns in problems and strategies for solving them. Detailed case studies of sites that apparently have been successful (and complementary studies of sites that have not) would reveal more about “what works” that is of practical utility.

Management Accountability

“These meetings were not initiated to be adversarial, but as a way for [you] to become effective, efficient and to think outside the box.”

– Police manager, to participants at a headquarters meeting

In our last report, we noted that the police department’s new focus on management accountability had just begun. In February 2000, the Office of Management Accountability (OMA) was established to provide “the necessary authority and the appropriate organizational purview to bring about an overall improvement in the management of the Chicago Police Department and to intensify the city’s community policing strategy in all organizational bureaus of the Chicago Police Department” (OMA Statement of Purpose). Directed by a deputy superintendent and staffed by about 12 sworn and civilian employees – including management analysts and crime analysts – this unit works to ensure that all CPD personnel and resources “are linked to strategies developed to address crime and disorder jointly identified by the community and police at the beat and district level.” The 25 police districts are responsible for identifying local priorities, planning strategies to address them and then executing their plans effectively. The role of OMA is to oversee this process, holding district commanders and area deputy chiefs (commanders’ immediate superiors) accountable for carrying it out.

One of the most visible aspects of the accountability process is meetings. At the district level, members of the management team are to meet monthly to carry out their planning and

implementation duties; these are “Level One” meetings. All or several of the five districts composing each area participate less frequently in “Level Two” meetings. At these meetings plans and accomplishments are reviewed, and area chiefs have the authority to reallocate some of their officers. To a certain extent, the area chiefs can reallocate some of their officers to respond to pressing needs in particular districts. To do this, they have created special teams comprising officers “borrowed” from all parts of the area. These teams are assigned for a limited period to address the most serious problems in the entire area. Third-level meetings are held at police headquarters. At these, the department’s senior executives assess the effectiveness with which the department’s core missions are being addressed.

While meetings are an important component of the accountability process, the organizational strategy behind them is much larger. Accountability is a way of thinking and working, all the while knowing that one’s decisions and actions are under constant scrutiny and may need to be justified. Accountability involves “doing your homework,” crafting well-thought-out plans, and monitoring and documenting efforts to address the problems that have been prioritized. Standards imposed by accountability are an expression of what is valued by the organization, and what behavior is expected or discouraged. Real “buy-in” by members of the organization to accountability, like to CAPS as a whole or to other police initiatives, is crucial to its success.

What led to this new focus? Our report of 1999 documented a number of shortcomings in the implementation of CAPS, and it singled out the absence of meaningful planning and problem solving in particular. In response, a CAPS Project Office was established within the police department to conduct an assessment of the efficacy of the strategies and procedures that comprise Chicago’s community policing program, and to gauge the true level of CAPS implementation in the districts. The department’s internal assessment concluded that, while many elements of community policing were integral parts of the way the Chicago Police Department did business, the problem-solving component of CAPS had not gotten very far. This was attributed, in part, to weaknesses in the organization’s accountability process. No one above the level of sergeant was really in charge of many important elements of CAPS, and no one was really overseeing how well they were carrying out their CAPS responsibilities. This led to significant changes in the department’s management structure – changes detailed in a series of steps in our 2000 report.

Our analysis of Chicago’s accountability process began in advance of the 2000 report, which described the police department’s fledgling efforts. Since the 2000 report we have attended four of the orientation sessions that launched the project, 15 headquarters reviews, six area-level meetings and 11 district management team meetings. We focused on three selected districts to study the process in practice. Project staff attended accountability meetings at all levels for each of these districts and interviewed key members of their management teams. We interviewed OMA staff on repeated occasions, and on two occasions interviewed 13 district CAPS management team leaders (“CAPS lieutenants”). As is the case in other sections of this report, our description of the accountability process presents a snapshot in time. The process has evolved significantly over the past two years, and doubtless will change again.

The Accountability Process

In this process, managers are held accountable for four core functions. As described in OMA's Statement of Purpose, they are:

- *“Reducing chronic crime and disorder identified at the beat and district levels.”* Like any large organization, the police department has a number of goals, some driven by their mission and others by bureaucratic impulses. The first part of this statement of purpose reiterates that some goals are more important than others; the second that patrol units out in the field will decide what they are. This signals an important aspect of Chicago's accountability plan – that authority and responsibility for managing operations have been decentralized. Another important feature of the process is OMA's emphasis on involving the efforts of many of the department's specialized units in tackling priorities set at the local level by officers in the Patrol Division.
- *“Identifying and containing or eliminating emerging crime trends and patterns.”* The districts are supposed to show managerial flexibility by adapting quickly to changes in their immediate environment, without waiting for orders from headquarters. Identifying crime trends has been greatly facilitated by the new information technology that is described in the next section of this report. A common refrain at accountability sessions is that the police are the “crime experts” and should be able to detect trends before public complaints reach a crescendo.
- *“Organizing community involvement and responding appropriately to community priority concerns.”* This is a fundamental CAPS goal, integral to the department's commitment to community-oriented problem solving. The beat community meetings that were described earlier in this report are one mechanism for identifying these concerns, and steps in the accountability process are aimed at ensuring that they are addressed. The CAPS Implementation Office is responsible for organizing community efforts in the problem areas prioritized by the districts.
- *“Managing the efficient use of police personnel and other resources.”* There is always more police work to be done than there are officers available to do it, so commanders have to make choices about how to allocate their resources. The accountability process holds them responsible for doing that wisely. In addition, as part of the process the district's managers are invited to identify organizational impediments to getting their work done; these are labeled “management detractors,” and OMA is committed to solving them, as part of making accountability a “two-way street.”

Operationally, this model works as follows. Each district chooses its problems and strategies, based on an analysis of its data, and then concentrates its resources on them. In its oversight role, OMA asks, “Are you implementing the strategies you chose?” If the district is doing what it planned, the question then becomes, “It is working?” Along the way, OMA asks

questions such as, “Are you managing efficiently?”; “Are the community and city services involved?”; and “Are outside units involved?”

In addition, inspectors from Auditing and Internal Control, which was incorporated into OMA in early 2001, expanded their purview by adding problem-solving activities to its checklist. Field inspectors now assess the extent to which districtwide operations are correlated to priority problems as listed on beat plans. Over the span of a month members of this arm of OMA examine proposed strategies and progress reports, as well as at whether the problems are assigned as missions to beat officers at roll call. The inspectors attend meetings at the beat level and check to see whether city services have been enlisted whenever appropriate, and whether beat facilitators, the District Advisory Committee (DAC) chair and CAPS office are involved in problem-solving efforts. At the end of the month-long process, inspectors report on their findings and make recommendations that are shared with district commanders. In addition, a sergeant working directly for OMA attends beat meetings four days a week to monitor their compliance with departmental standards. This incorporation of important elements of CAPS into the department’s routine internal review processes marks an important step in making these part of the everyday business of the organization.

Because the accountability process is a departure for the CPD, it was introduced slowly, and a great deal of advance warning was issued concerning its new expectations. The OMA head met with each district’s management team to explain the new rules; describe what he would be looking for; and advise them about how to prepare for each step of the process. Everyone knew something about New York’s CompStat, so part of the message was that this was to be different. Some have described Chicago’s accountability process as a “kinder, gentler” version of the New York model. Proponents say that it does not have the same “bite” as New York’s, but that is because it is not needed. Accountability meetings – especially headquarters meetings – were never intended to be a “gotcha!” experience. From the very beginning, the OMA head and his staff focused on their four-part mission and clearly articulated what they were attempting to accomplish. Early district- and area-level meetings were clearly “run-throughs” rather than hard-nosed inquisitions. As the OMA deputy superintendent put it at one area meeting, “Be on top of the four core activities.” Our observer noted:

[The OMA head] stated that this was pretty easy to figure out now. They are the management team that develops these strategies; once they agree on the strategies, they need to see if the strategies were carried out. This is the key, he told them. He then said they needed to fill out the area planning sheet summarizing the strategies, putting together a time line, and getting information from specialized units. His office will call them one or two weeks before the headquarters meeting to get this information from them for analysis. He told them, “If crime is going up in any category, you can assume we’ll probably ask questions about it.” And regarding community concerns he said, “If something blips up, you can be sure we’ll ask about it.”

At these orientations the deputy superintendent informed the group of why he was there and what he was looking for. To the observer, questions asked and issues focused on were

obvious; observant managers caught on quickly as well. However, there remained (and remains) an entrenched belief that OMA is “out to get them.” At a district planning meeting held just after the district’s headquarters session, one manager lamented, “No matter how prepared we are, [OMA] always finds something.”

This was a departure from the way the department customarily did training. Usually, they only trained groups of officers of identical rank, but in this case the entire management team sat through orientation sessions as a unit. They were to work together to make the accountability process work in their district, and this helped prepare them for this team-oriented concept.

District strategic operational plan (SOP) sessions. There are three levels of accountability meetings. One commander used a baseball analogy to describe the process: “Level One is spring training; Level Two is pre-season.” This would make Level Three opening day. Level One is the SOP meeting, and creating, implementing and evaluating the effectiveness of the district’s SOPs lie at the heart of the accountability process.

Figure 16 presents the first page of an SOP worksheet, which guides the collection of information needed to plan responses to priority problems. It specifies the data that need to be extracted from the Department’s information systems, and walks districts through the process of identifying offenders, victims and locations that constitute the core of the problem. It calls on the district to propose goals for itself; problems that are elevated to the level of a district priority often present tough targets and often transcend beat boundaries, and police need to consider what they realistically can hope to accomplish. At any given time districts are working on about three SOPs, so they also have to make hard decisions about the level of resources they can direct at any one of them. The second page of the worksheet documents the assignment of responsibility for executing specific components of the plan, and the next lays out a format for displaying monthly data evaluating progress on the problem.

At district meetings, the local management team (composed of the commander, three watch commanders, a tactical lieutenant, the CAPS management team leader, the Community Policing sergeant, and – perhaps – the civilian DAC chair) assesses and revises the district’s SOPs, discusses the district’s efforts for the past month, makes new plans, and tackles management issues. In addition to district representatives, others in attendance might include the CAPS Implementation Office area coordinator, area detectives, representatives from the area deputy chief’s office (or the deputy himself), an attorney from the city’s Law Department and the civilian district administrative manager. There was a great deal of variation in how the meetings we observed were conducted. Sometimes they resemble mini-headquarters sessions, with formal presentations, PowerPoint presentations and structured discussions of the four elements of the process. Sometimes they are extremely informal, quickly concluded and superficial.

Figure 16
Strategic Operational Plan Form

STRATE OPERATIONAL PLAN WORKSHEET BEAT PLAN FORMS SUMMARY (DISTRICT PRIORITY PROBLEM) CHICAGO POLICE DEPARTMENT	1. DISTRICT		2. PROBLEM REF. NO. _____		
	3. DATE WORKSHEET DEVELOPED:		4. CROSS REF. NO. _____		
5. DISTRICT PRIORITY PROBLEM TITLE:					
6. BRIEF DESCRIPTION OF THE DISTRICT PRIORITY PROBLEM			7. WHAT BROUGHT THIS PROBLEM TO YOUR ATTENTION? (USE AS CRITERIA FOR MEASURING IMPACT OF PROBLEM-SOLVING)		
8. PROBLEM OCCURS DURING:			CHECK ALL THAT APPLY:		
<input type="checkbox"/> 1ST WATCH	<input type="checkbox"/> 10 SECTOR	SPECIFIC DAY(S):	SPECIFIC HOUR(S):	MANDATORY INFORMATION:	
<input type="checkbox"/> 2ND WATCH	<input type="checkbox"/> 20 SECTOR			<input type="checkbox"/> OFFICER OBSERVATION	<input type="checkbox"/> OTHER CITY AGENCY
<input type="checkbox"/> 3RD WATCH	<input type="checkbox"/> 30 SECTOR			<input type="checkbox"/> SUPERVISORS	<input type="checkbox"/> OTHER COMMUNITY CONTACT
				<input type="checkbox"/> OTHER UNITS	<input type="checkbox"/> OTHER _____
				<input type="checkbox"/> ELECTED OFFICIAL	<input type="checkbox"/> # OF INCIDENTS / RD NOS _____
					<input type="checkbox"/> ICAM (INCLUDE IN TRACKING FOLDER)
					<input type="checkbox"/> # OF BEAT PLANS _____
					TIME SPAN USED: FROM: _____ TO: _____
9. ANALYSIS OF PROBLEM: DESCRIBE OFFENDER, VICTIM, LOCATION / ANSWER WHO, WHAT, WHERE, HOW AND WHY? (USE ADDITIONAL PAPER IF NECESSARY)					
LIST INFORMATION - OFFENDER(S)		LIST INFORMATION - VICTIM(S)		LIST INFORMATION - LOCATION	
10. DEVELOPMENT OF TARGET / GOALS: WHAT WAS REALISTICALLY ACCOMPLISHED TO ADDRESS THIS PROBLEM?					
11. WHAT STRATEGIES WERE USED TO ADDRESS THE PROBLEM? (CONTINUE ON OTHER SIDE OF FORM)					
A. LAW ENFORCEMENT STRATEGY:			B. COMMUNITY STRATEGY:		
RESPONSIBILITY ASSIGNED TO: (POLICE PERSONNEL)			RESPONSIBILITY ASSIGNED TO: (COMMUNITY CONTACT AND POLICE LIAISON)		

In a “formal” district meeting, an ordered agenda covers topics similar to those focused on at headquarters: discussion of SOPs, emerging crime trends, community concerns and management issues. The meeting is typically led by the commander, although the CAPS lieutenant may take the lead at times. When the process was new, the OMA director attended these meetings to get them on track. Later, a senior member of his staff would occasionally attend these meetings to make sure they stayed on track. He would explain that this was “step one of three,” review the four core functions and step into the discussion on occasion to get them “accustomed to the types of questions that will come up at the headquarters meetings.” He would prep them for step two, the area meeting, where the area chief would “identify resources to be harnessed to deal with the district’s identified priority problems.” Once in a while, organizational problems in implementing a strategy would come up at this level, and commanders were encouraged to mention these “management detractors” at their headquarters meeting. An early example was the inability of districts to secure unmarked police vehicles in order to do undercover surveillance operations.

SOP meetings are generally held monthly, and their quality varies even within a district. Sometimes they are held purely for information sharing – gathering reports on actions that had been taken in the previous month so that data could be added to the assessment section of an

SOP. At other times, and especially just before and after a headquarters session or when an SOP is about to expire, there is more discussion, evaluation and new planning. At effective SOP meetings, there is discussion of both the success of strategies and why some of the things they have been trying may not be working, along with proposals for new strategies. Our observer at one meeting noted:

One example of management team problem solving focused on the problem of theft from autos. The commander and one watch commander threw out ideas on how to tackle this problem, while other managers occasionally added their thoughts.

There is an action component to the beat SOP meetings: they end with some clarity about activities the district plans to undertake. Our observer noted this at one district meeting:

One got the impression that this isn't a group that says, "Good, that's over. Now we don't have to do it for another month." Attendees came away with tasks and planned to follow up on some issues next time. The district also had a good grasp of the planning process. They put forth ideas for dealing with an emerging crime trend, planning to review these efforts and create an SOP if the problem persisted.

Area accountability sessions. Level two is the area meeting. An area meeting is defined as an "ongoing, regularly held meeting at which the area deputy chief attempts to coordinate and optimize the strengths of specialized units to impact trends and conditions in the area's five districts." While districts meet monthly to discuss SOPs, area meetings are held less frequently. They are required to be held quarterly, though they may be held as infrequently as once a year, and often they are held just before a headquarters session. These meetings tend to be more formal than the district meetings and feature a PowerPoint presentation, formal seating arrangements and an audience sitting on the sidelines. The area deputy chief generally leads these meetings, though sometimes a district commander will conduct a portion of the meeting. The format usually mirrors that of headquarters meetings, with each district taking its turn at addressing the four categories of questions likely to arise there. Usually two districts are called to the meeting, with each taking its turn in the "hot seat." These meetings are attended by various police area managers as well as by the district management team. Area detectives in particular are likely to be quizzed about how they are assisting the district. The area chief may ask for updates about what the district has been working on. Some active problem solving occurs here as well. Community concerns are often fleshed out and given more discussion time here than at headquarters sessions. In addition, it is common to see a representative from the CAPS Implementation Office called upon to speak or be told what to do to help the district.

Although the formal agenda for these sessions is standardized, the area chief sets the tone for the meetings and determines their effectiveness. In some instances, the area chief takes control and tells those present what they are required to do; there is no discussion at this moment. In other cases, the chief takes on a facilitating role and elicits discussion by participants. There might even be discussion among district representatives and the special units

attending, with the latter being called on to explain what resources they can bring to bear on the problem being discussed. And, in some instances, the area chief only goes through the motions and does not contribute much substance to the meeting. Differences in how well commanders prepared for these meetings were evident; some were on top of their district's numbers and status, while others struggled to answer the questions posed to them. The first area meetings were more orientation than strategy sessions, for the districts often had to first be taught the basic concepts. Subsequent meetings were able to skip this educational component and proceed directly to the task at hand.

Area sessions also offer a forum at which district commanders can make requests for assistance from their chief and other units present. The creation of area saturation teams is an excellent example of the nimble resource reallocation that the accountability process aims to encourage. In this case, area deputy chiefs created teams of officers that they "borrow" on a rotating basis from their districts. They reassign them to support specific projects or to respond to crises in particular parts of the area. The Areas – not downtown – thus are in a position to allocate resources based on their more intimate knowledge of local problems and capacities.

Signs of new expectations for the department's many special units can be seen at area meetings. Units usually called upon to provide more help to the districts include Detectives, the Special Operations Section (which provides extra plainclothes officers for special projects), the Public Housing Unit, the Youth Division, the School Patrol Unit, the Public Transportation Section and Vice Control. The only thing district managers can do when they need other units' help is file interdepartmental support service requests (IDSSRs) for assistance. But at the area level these units are called to the table and expected to take an active role in the planning process and commit themselves to action. The area planning process puts pressure on special units when it requests them to focus their activities on geographically defined problems that support district priorities, and to provide feedback to beat officers and district managers. At one area meeting we observed, the OMA director issued a warning to representatives of special units that they should expect to be grilled at headquarters sessions concerning the effectiveness of their response.

Often the districts had to be cajoled into requesting help from units outside the Patrol Division. Because they had little success enlisting the assistance of outside units in the past, convincing the districts that they should rely on them was a challenge, and successful area meetings addressed the traditional autonomy of specialized units head on. After one area meeting our observer reported:

[The area deputy chief] proceeded by asking various specialized unit representatives to speak. The area detective commander promised to assign gang specialists to assist district gang teams and to provide them with intelligence on local gangs as it relates to narcotics distribution. Special Operations vowed to increase their efforts in the district's SOP areas as well as to disseminate reports on what they have done in a timely manner. Preventive Programs would work with the Community Policing Office to schedule gang prevention workshops. The CAPS Implementation Office's planned strategies included encouraging community involvement in identifying narcotics locations, organizing marches

and promoting involvement in court advocacy – especially having court advocacy volunteers monitor drug cases submitted to the community prosecution unit.

Effective area meetings feature vigorous discussion of priorities and debate over the allocation of the area's resources, and commitments by special units to support district projects.

Headquarters accountability sessions. The most formal meetings are held at police headquarters. They began in November 2000, but it was not until February 2002 that every district had experienced its first one. One district is showcased each time. Until the conclusion of the first round of headquarters sessions, each district was notified a few weeks in advance of its debut. This set in motion a clear and stress-inducing deadline for the districts to work toward; one CAPS lieutenant told us, "it's like studying for the bar exam!" Since February 2002, districts have been given less advance notice. Districts are now usually chosen because OMA has identified a new crime pattern or an increase in incidents related to one of their priority problems, and districts that carefully monitor their crime figures can anticipate being called upon. In addition, districts that are doing well but have not been reviewed for a while might be chosen.

Headquarters sessions force a block of time onto the busy schedules of downtown executives during which they can focus on strategic and management issues rather than on the endless phone calls and mini-crises that otherwise fill their day. Because their ability to independently assess the performance of the districts is also on display, OMA staff work hard beforehand to organize data and get their analytic assignments completed. These accountability sessions represent a dramatic departure from business as usual at the CPD, for in the past districts and units had usually enjoyed freedom from close scrutiny. In effective meetings, there is evidence of whether or not announced plans were actually carried out; if "cops are on the dots" (if they are working where the crime is); if concerns expressed by the community are being attended to; and if the department's numerous and highly independent specialized units are contributing to the districts' efforts.

Present at a typical session are the superintendent; five or six of the department's most senior deputies; the chiefs of Detectives, Patrol and Organized Crime, as well as heads of other special units; the area deputy chief responsible for the district under scrutiny; and other police and city officials. In the beginning, districts that had not yet appeared at a session sent observers; they could be seen furiously scribbling notes throughout the entire session, and attendance often exceeded 100. Later, fewer visitors attended. On display front and center are all of the district's managers, seated in a row with identifying title cards. The head of OMA leads the discussion, and behind him staffers take notes and control the display of a PowerPoint presentation on a huge LCD screen that fills the front of the room. The display is used to document the points prepared in advance by the staff.

The districts we monitored varied in how they prepared for the meetings, but none took the upcoming meeting lightly. In some the district commander relied on the CAPS lieutenant and community policing sergeant to do the research and prepare answers to questions that they anticipated. At the other extreme, one district management team held a practice headquarters

session at which the commander quizzed his entire management team as if he were the OMA head. Districts are supposed to have mechanisms in place to keep ready for an assessment at any time. However, when called for a headquarters meeting, some districts' managers and their staff must rush to get the district paperwork in order for the meeting, which is perhaps an indication that accountability is not yet routine.

The sessions generally begin with a brief overview of the purpose of the accountability process, including a description of its four core functions, and then a review of the status of the district. On the screen appear trend lines for general crime, arrest figures and measures of district workloads, including the ratio of crimes to officers assigned to the district. More interesting to the questioners are changes in violent and property crimes in the district, using as a benchmark the previous year's comparable figures. Another general productivity measure is arrests per officer; in this instance, the top managers are interested in which officers are making arrests, because they want uniformed patrol officers to remain active rather than turning over enforcement to plainclothes officers and other units.

The bulk of the meetings are focused on assessing the effectiveness of the district's actions against specific problems the management team pledged to take on in their district plans. A typical plan might focus on garage burglaries in four beats, gang loitering in five beats or prostitution in three beats. Having gone through the process of identifying and prioritizing these problems and describing resources they would allocate to solving them, commanders at the headquarters meetings face an analysis of how well they executed the plan and how effective they were in resolving problems they identified.

The procedure at accountability sessions is to step methodically through the two or three priority problems identified by the district and review the list of five or six strategies that commanders typically committed to fielding against them. As discussion ensues, a summary of each plan flashes on the screen at the front of the room. The upper left corner of Figure 17 presents the summary of one district's plan to tackle drug houses in three of its beats. The plan proposed using other department units and the city's Strategic Inspections Task Force to put pressure on drug houses; to increase visibility of uniformed patrols while at the same time slipping undercover officers into the area; to try to enlist community support at beat community meetings; and to clean up and improve lighting in targeted sites.

The review of strategies during headquarters sessions is usually as much about process as it is about outcomes. Questioners at the head table are willing to defer to the local expertise of district managers about which problems should be considered priority and which strategies should be used. Instead, they focus on the effectiveness of the plans. Following through on the promised strategies is known as "seeing that the ticket gets punched." So, if the plan was to press the prosecutor for "felony upgrades" for arrestees deserving substantial punishment, OMA

Figure 17

District Accountability Session Presentations

District Strategic Operational Plan
NARCOTICS

Plan Developed: 01 September 2000

Targeted Locations on Beats 12, 21 and 35

- Request, via the Area Deputy Chief, use of the Strategic Inspection Task Force to target identified "drug houses".
- Request Tactical Missions and conduct Reverse Stings at each targeted location.
- Increase Patrols at each targeted location. One civilian dressed team per watch to enforce narcotic related laws (A.N.O.V.'s, disorderly conduct and soliciting unlawful business).
- Increase Police visibility by conducting outside roll calls at targeted locations.
- Encourage community input regarding narcotic sellers, dealers and suppliers. Reintroduce residents to C.A.P.S.
- Increased lighting and tree trimming. Request major clean up program.

NARCOTICS
City Service Strategies
Beats 12, 21 and 35
June 2001 YTD

<u>Abandoned Vehicles</u>		<u>Graffiti</u>	
City Service Requests	1,418	City Service Requests	226
City Service Requests Open	50	City Service Requests Open	0
Submitted by Police	20	Submitted by Police	6
<u>Vacant and Abandoned Buildings</u>		<u>Tree Trimming</u>	
City Service Requests	101	City Service Requests	244
City Service Requests Open	0	City Service Requests Open	6
Submitted by Police	21	Submitted by Police	6
<u>Street Lights Out</u>		<u>Alley Lights Out</u>	
City Service Requests	227	City Service Requests	36
City Service Requests Open	0	City Service Requests Open	3
Submitted by Police	0	Submitted by Police	0

74

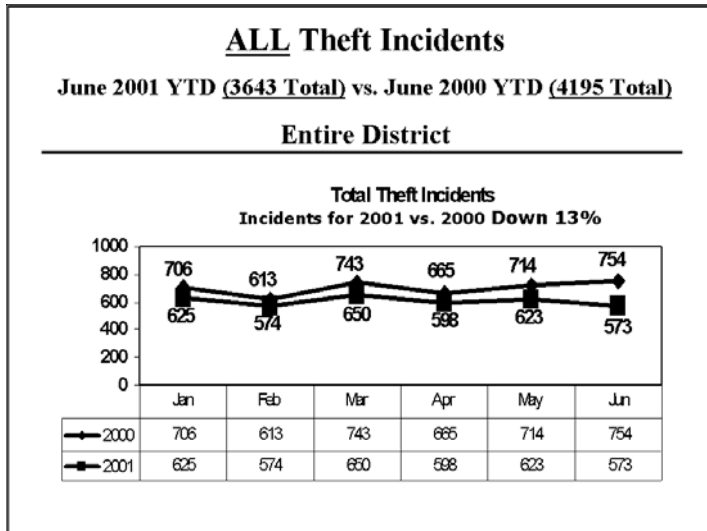

Community Concerns
Miscellaneous
January – April 2001 Beat Community Meetings

Beat 1112	Shootings	1100 N. Sxxxxxxd	2 nd /3 rd Watch
Beat 1114	Loitering	4100 W. Wxxxxxx	1 st Watch
Beat 1115	Gang Recruitment	Gxxxxx School	2 nd /3 rd Watch
Beat 1122	Peeping Tom	220 N. Hxxxxx	All Watches
	Trucks Parking Illegally	200-220 N. Hxxxxx	1 st /3 rd Watch
	Loitering	3800 W. Fxxxxxx	3 rd Watch
	Abandoned Autos	3832 W. Wxxxxxx	3 rd Watch
Beat 1123	Abandoned Autos	3300 W. Mxxxxxx	All Watches
	Prostitution	3500-3600 W. Mxxxxx	All Watches

analysts track the total, percent and trend in felony upgrades for district arrestees. If the commander promised to assign foot patrols to deal with a problem, charts appear on the screen displaying counts of foot patrol assignments before and after the plan went into effect, and the staff would have reviewed hundreds of activity reports to see if officers actually recorded any forays on foot in the vicinity of the problem. If there was a promise to involve the community, the head table would call on a representative of the CAPS Implementation Office to rise and give an account of activities that had been organized in the target area (for example, meetings, marches, the formation of block clubs, intensive neighborhood clean-up projects, phone trees, court advocacy participation). If city service agencies were able to contribute to solving a problem (for example, by towing cars, or installing new street lights or signs), analysts forage through city databases to count the number of service requests that were filed targeting the problem area. The upper-right quadrant of Figure 17 presents an analysis of city service requests filed for beats with a narcotics problem. Compared to many, a lot had been done in this district.

Part of the discussion of priority problems is an analysis of the effectiveness of the district's efforts to counter them. OMA analyzes "before versus after" comparisons of crime statistics or calls for service, and comparisons of "this year versus last year." The lower-left corner of Figure 17 presents trend lines for theft that were displayed during one district's headquarters accountability session. The numbers for 2001 were below those for 2000, and in June things looked a bit better still, so this was deemed evidence of success.

OMA analysts also produce analytic maps that identify concentrations of crime. For one shoplifting SOP they identified short stretches of several commercial streets that accounted for a disproportionate percentage of all crime in the city, much less the district. OMA's crime mapping capacity also enables the staff to compare district plans with information from the department's data warehouse, to ensure that resources are being deployed in areas of need. The map presented in Figure 18 was displayed on the screen at one headquarters accountability session when the discussion turned to its narcotics plan. In this case, the district's problems were extremely concentrated, and the cluster of beats identified as its priority (which are indicated in the map) passed the test.

While these analyses frequently point to some real successes, it is the nature of most chronic crime and disorder problems that they do not go away quickly – if they were that easy a target, everyone in the room would not have devoted so much time to them. Sometimes there is a constructive discussion of what else can be done. This might involve a debate about possible changes in city ordinances, and in that case the department's lawyer would rise to make a few comments. Senior managers also provide examples of how they had handled similar problems during their days on the street. Police consider the city's pawn shops and second-hand retail stores as major underlying causes of crime, because thieves can convert items they steal to cash there, so there is frequent discussion of how to monitor their sales and identify "serial pawnners."

Figure 18
Headquarters Session Crime Map

NARCOTIC INCIDENTS
ICAM MAP - Entire 008th District
June 2001 – August 2001

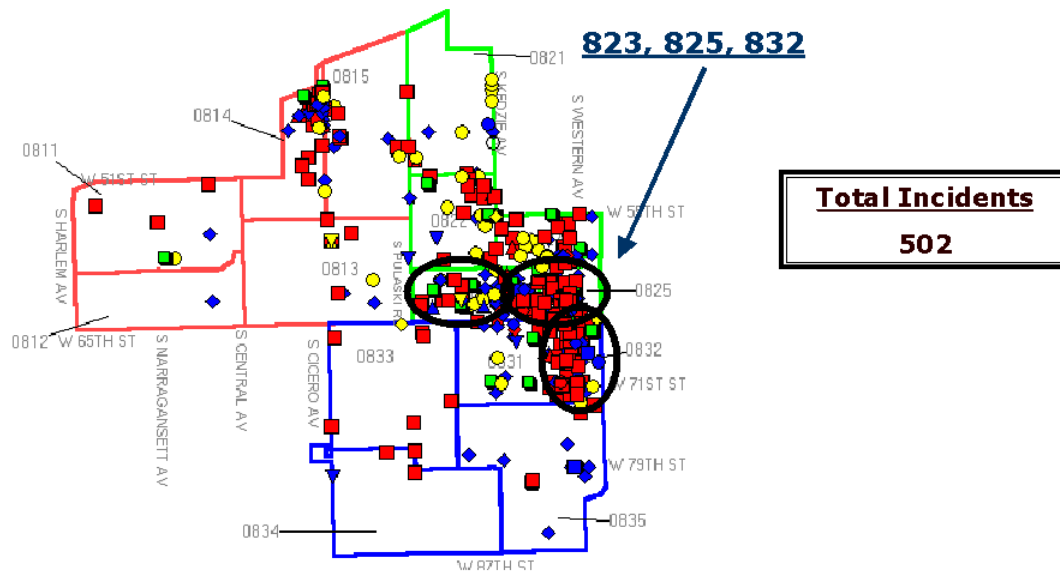

Sometimes these sessions identify additional tasks for detectives and other special units. At each session the head of the area detective unit sits at a table near the front and anticipates being quizzed about detectives' contributions to addressing the priority problem under discussion. A departure from traditional practice, this reflects a conscious attempt to force detectives to share information and act in concert with uniformed patrol officers. The detectives are occasionally referred to as a "support unit," which does not fit their self-image. If the problem is an outbreak of aggravated assault, a questioner at the head table might ask about whether detectives are intensively interrogating arrestees about where they had gotten their guns. The analysts sitting behind them will have a screen ready that analyzes the proportion of assaults assigned to street detectives for investigation rather than being dealt with on the telephone or closed without further investigation. If the district is home to a large contingent of public housing residents, questions will be directed at the representative of the area's public housing detail. Records filed by the Special Operations Section – a roving squad that can be called on to flood a troubled area with plainclothes officers – will be examined to make sure they were making the right kinds of arrests in the right places.

Many observers would agree that the department is organized into separate bureaucratic fiefdoms, but with sufficient pressure they can be pulled together to work in unison on specific problems. At one headquarters session a deputy superintendent noted that he wanted to see special units pay as much attention to crime trends as do district commanders, and to quickly reallocate their resources as the need becomes apparent. There were visible effects of the accountability sessions on the insularity of two department fiefdoms – Detectives and Special Operations – during the first 18 months of the new accountability process. Other distinct units, such as the CAPS Implementation Office, City Law Department attorneys and the department’s computer systems unit are also called upon to support police efforts.

Problems identified as priorities by the district do not take up the whole agenda. OMA analysts also work on identifying emerging crime trends. These are new patterns that officers and residents should be on the lookout for, and that might be “nipped in the bud” if solved quickly. An early example was thefts of auto air bags, which suddenly skyrocketed in just one of the city’s 279 police beats due to the efforts of an entrepreneurial thief. Other emerging trends might spawn numerous “copycat” offenses if they become widely known. This was threatened when gangs in one district began setting fire to each other’s cars in the wee hours of the morning, as their rivals slept. OMA expects the districts eventually to be able to do this kind of crime analysis on their own, using the department’s new information technology.

OMA also struggles to independently assess whether or not districts are responding to residents’ priorities. This is a fundamental goal of CAPS, and integral to the department’s commitment to community-oriented problem solving. One approach used by OMA is to study reports filed by officers who attend each beat community meeting and pull out what was reportedly discussed. Analysts also read the minutes of District Advisory Committee meetings and reports from their subcommittees, and examine patterns of calls to the city’s nonemergency 311 city services hotline. For about a year, information about community concerns was supplied by the civilian staff of the CAPS Implementation Office. Each month the grass-roots organizers sent a list of unresolved problems downtown, where they were summarized and classified by district and beat before being sent on to OMA. Most of these concerns focused on neighborhood problems, but a significant number pointed to shortcomings on the police end of CAPS. These included complaints about poor leadership and a lack of officer continuity at beat community meetings, a lack of visible follow-through on problems discussed at the meetings, unprofessional responses by 911 operators and slow police response to calls. These reports, which were judged to be too brief and undetailed, were later discontinued. It is noticeable, however, that while our observational study of beat community meetings found complaints about police registered at 44 percent of beat community meetings, we never saw these complaints making it onto a community concerns list.

At accountability sessions, commanders can be confronted by lists of problems assembled by OMA analysts and quizzed about what they are doing about them. Community concerns that are linked to an official district priority are considered. Figure 17 listed community concerns that were gleaned for display at one headquarters session. They ranged from a “peeping

tom” to gang recruitment at a local school, and the commander was queried about several. However, OMA is really interested in the process that districts have in place for identifying community concerns and responding to them. For example, someone in each district – usually the CAPS lieutenant – is supposed to be responsible for reading beat community meeting reports and taking note of issues that are described there. A senior district manager – often a watch commander – should have the task of assigning officers to work on them, monitor their progress and decide when issues have been successfully resolved. To the extent to which their information systems enable them to monitor community concerns, OMA analysts track the concerns from downtown. Districts that do not have some kind of systematic process in place for responding to problems raised at beat community meetings hear about it at accountability meetings.

The sessions also examine internal management issues, some of which are of major importance to the community as well. The districts are pressed to reduce their reliance on overtime – an expensive item for the city – and to keep after officers who seem to be abusing the department’s liberal sick-leave policy. The cost of repairing district vehicles is noted in “car crash” discussions. OMA analysts compare the amount of time officers spend answering various kinds of calls, with an eye toward keeping that number down. There is usually mention of trends in complaints by the public against district officers alleging verbal abuse or use of excessive force. There is pressure to identify and counsel repeat targets of these complaints, and commanders have described roll-call training sessions they held that stressed officer restraint. There is also an examination of management issues for detectives. This includes clearance rates, overtime and frequency with which cases are filed away without a real field investigation.

In theory, the headquarters accountability sessions are to be a “two-way street,” providing the districts and OMA analysts with an opportunity to identify bottlenecks, known as “management detractors,” that hinder getting the work done in any large organization. We observed discussions of problems in entering and retrieving data from the department’s data warehouse, and the absence of reports that could provide useful information. Commanders sometimes point to equipment shortages and the constant drain of staffing levels for special events. However, not much attention is devoted to these topics at headquarters meetings; thus these discussions are rare. Historically, members of the organization have been reluctant to put their careers in jeopardy by criticizing their superiors, and this aspect of the culture will be difficult to change.

The accountability process has evolved over time. The basic appearance of the meetings and the major topics that are discussed have remained unchanged. However, since the completion of the first round of headquarters sessions with each district, the rationale for choosing districts to reappear has shifted to the emergence of unexpected crime trends. Some standard questions asked in the past (for example, “Are you checking open warrants?”) have been replaced by new ones (for example, “Are vehicles linked to narcotics arrests being seized?”). There are perhaps fewer surprises, because commanders now know what to expect and many have procedures in place so that they can “cram” for possible invitations to come

downtown. Displays at the front of the room have become more sophisticated, and databases that can be tapped to monitor the districts have become richer. But OMA still wants to know if commanders know their districts; if the districts are implementing strategies they specified in their SOPs; if they are effectively using all the resources at their disposal to combat priority problems; and if the efforts are working. Individuals sitting on both sides of the table will also change, but the reason they are all there remains the same: “To ensure, to the maximum extent possible, that resources are linked to strategies that address crime and disorder.”

Accountability as a Change Strategy

“[Each accountability meeting] was a learning experience and handled as such. Each step of the way we’re expected to improve.”

– District manager

We have described the accountability process as a seemingly endless series of meetings, but it has deeper purposes. It is intended to set in motion internal organizational processes that must happen for the four goals of accountability – reducing crime and disorder, responding to emerging trends, speaking to residents’ concerns and managing efficiently – to be realized. This section assesses some of those processes in light of our observations and interviews.

Clarifying the mission. Mission statements express the core values of an organization in a sufficiently tangible form to suggest that there are ways in which success in achieving them can be measured. They commit members – from the chief on down – to those values and success measures. Organizations can drift away from their core missions, especially in the public sector, where success at “the bottom line” does not directly translate into their paychecks. Organizations tend to become self-serving when they can, focusing only on problems that comfortably fit their practices and letting internal administrative issues and bureaucratic infighting take precedence over real work. They may develop performance evaluation criteria that do not reflect the needs of the rest of the organization. As one top manager put it, “It’s the natural thing in bureaucracies – especially in those with specialized expertise – to go off and focus on their own goals, not the organization’s goals. They go their own way.” Too much of the organization’s time gets caught up in solving the red tape problems and quelling turf battles that erupt as a consequence.

Our view is that senior officials within the police department recognized that the organization was too focused on tradition and administrative matters rather than on changing conditions in the neighborhoods. The response was a plan to instill new efficiency and effectiveness into the organization. Rededicating the department to reducing crime enables them to set specific, measurable goals for which mid-level managers can be held accountable. It also enables them to apply new technologies to policing. The accountability process has refocused police efforts on long-standing problems; an examination of the problems prioritized in the district’s plans demonstrates that serious crime and disorder problems have taken first place on their agendas.

Developing a culture of internal accountability. As early as 2000, OMA staff suggested that their goal was to put themselves out of business. That is, their intention was to eventually pass control of the accountability process from headquarters to the five administrative areas of the department, decentralizing responsibility for keeping the organization focused on chronic crime and disorder problems. There is good reason to choose the Areas for this. Areas may be small enough that executives at this level can keep abreast of conditions there, although they are still quite large. The largest police area in Chicago (Area 5, on the Northwest Side) is the same size as San Francisco, and Area 1 is larger than Milwaukee. The smallest police area in the city, Area 4, is only slightly smaller than Minneapolis. But for this administrative hand-off to be realized, the organization needs to develop a “culture” of accountability; that is, it must be part of the routine business of the organization. Some elements of this culture are:

Know the District. Managers are expected to know the problems facing their areas. They must use the technological resources available to them to discover their own hotspots, crime spikes and crime patterns. In some departments this is the task of specialized crime analysts at headquarters; in those places the culture expects downtown to tell the operating units what to do. Chicago’s expectation that the districts would do their own crime analysis led to a mini-chorus of complaints about lack of training and staff, but the districts quickly learned how to handle the task. Forcing district managers to divert their attention from administrative and bureaucratic tasks to the crime in their district was one of OMA’s goals, and it succeeded. Managers do know their districts better. Whatever their other views, what we heard in interviews was that the accountability process “keeps us on our toes,” and this was overwhelmingly viewed as a positive step. There was a sense that accountability caused managers – especially commanders – to “keep on top of things” as opposed to before accountability, when people were “lax” or there was a tendency to “allow things to slack,” because no one was watching.

Now, according to one commander, the pressure of accountability makes the commander and watch commanders “painfully aware of what’s going on in the district and focusing on those problems.” During one headquarters session, a commander was obviously prepared. This impressed the deputy superintendent, who said their “stats were on track – did you get my notes?” to which the commander replied, “No sir, I know something about my district!” Many we interviewed would echo the sentiment expressed by one commander that the accountability process “created a forum for commanders to be challenged to know what’s going on in their district . . . [It] also made the management team more aware of the day-to-day operations and how to allocate their people. Accountability has created a leadership role for everyone.”

Manage Efficiently. Managers are expected to more effectively use resources that are already in their hands. This includes taking measures to curb complaints about officer misconduct, decrease the number of unanswered 911 dispatches, make sure officers are spending the right amount of time on assignment, and keep overtime use under control. These issues are routinely brought up at all levels of accountability meetings. Information is often shared among the management team, members of which discuss how to address their problems. Their responses can be timely. For example, in one district, squadrol crashes were a big problem. They

determined that mostly newer officers were responsible for crashes, and the district instituted training for them. As a result, the number of crashes went down. At headquarters meetings, commanders describe the practices they have in place to ensure that their officers are not abusing medical leave privileges, including checking on them several times a day by telephone and making it clear that they were needed at work.

Districts wanting more staff perform all these managerial tasks and see them as an “add on” to the long list of things they currently do rather than as an opportunity to work more efficiently. The lament that the districts do not have sufficient personnel is persistent – predating these new demands. Local commanders have long pointed to the various fairs, festivals and special events that draw away their staff, especially during the busy summer months, as the chief cause of their trouble. The arrival of management accountability provided some commanders with a new source of aggravation to point to, adding lamentations about the demands of accountability-related tasks such as crime analysis, and about the fact that the CAPS lieutenant position was created by depriving them of one of their field operations lieutenants. One remarked, “It’s OK to fire you for not doing your job, but first they have to give you enough resources to do your job. . . If they want to fully implement accountability, then give people the staff they need to get it done.” OMA’s response was that they would always have undone tasks and that district management teams had to make hard choices. But accountability has its supporters: “We should be called on the carpet every once in a while,” a manager commented, “to justify what we’ve done. It’s a tool to keep us focused, to stop us from getting sloppy.”

Manage as a Team. Managers are in agreement that the accountability process promotes teamwork; in fact, some stated that for the first time they feel as though they are part of a team. Survival – surviving headquarters meetings, in particular – binds management teams together, and though commanders are responsible for knowing their districts, it is their management team that gets them there. Savvy commanders delegate responsibility for answering some questions they anticipate at headquarters meetings to members of their staff who were responsible for dealing with the issue, thus giving them an opportunity to shine when they have done a good job. Assembling a competent team is more crucial now than it has ever been. To the department’s credit, it has many qualified people who can do this.

Stay Focused. One of the challenges of policing is that there are always more things that need attention than there are resources to address them. Management accountability recognizes the limitations of what police can do with the available resources, so it emphasizes focusing on priority problems, targeting specifically where the limited resources will have the greatest impact. Utilizing crime analysis, districts are expected to decipher the exact locations of the problem – which street, block or building, etc. – as well as the time the problem occurs and who is involved. Proper deployment of resources is an efficient way of dealing with the problem of limited resources. As one lieutenant put it:

In the past, there was a lot of good police work done, but it was in a spaghetti fashion, [that is] you would throw everything to the wall and something will stick.

Now information gets passed along better, crime trends can be spotted better and similarities in offenders can be spotted – all because of the database.

We found ample evidence that districts have become more focused. Strategizing about resource allocation is common at all levels of decision making. This may be one of the accountability process' greatest successes.

In addition, "hardening the target," or making potential victims less vulnerable, is a way to reduce crime without much police effort. Shoplifting, for example, is a crime for which labor to get victims to do more to protect themselves pays off. There is ample evidence that districts frequently use these strategies to focus their resources; this may be one of the accountability process' greatest successes. Discussions relating to resource allocation are common at all levels of meetings.

"Punch the ticket." Districts are expected to demonstrate that they have focused their resources on priority problems. The department's planning process calls for districts to identify priorities, draft plans to address them (the SOPs described earlier), and then carry through on those plans. The last step is known as "punching the ticket," and seeing that the ticket gets punched is a major focus of the accountability sessions. Everyone has limited resources, and the focus is now on concentrating those resources in specific areas, targeting specific problems where they will have the maximum impact.

There is evidence that districts are doing just this. Managers have always bemoaned the lack of manpower and resources to tackle all the problems in the district. The accountability process forces them to focus their efforts. A potential down side of this is that it encourages focusing too narrowly on what OMA can monitor, because that is what the district will be called upon to explain. At a beat community meeting we observed, residents were debating prior to voting on the beat's priority problem for the next six months. The beat officers who attended lobbied for their view; they described "OMA's computers," and argued for a problem against which they felt they could show success.

Make your numbers. This could be a logical final step to this process, but in Chicago, it is definitely not part of the equation. It is the final step in other cities, and police chiefs sometimes find specific crime reduction targets in their employment contracts. Chicago's accountability process calls on unit commanders to demonstrate measurable success at alleviating crime and disorder problems. To date, however, the department has chosen not to impose specific standards to be met by the districts. Of course, goal setting is a tricky business. Other departments have struggled to maintain the integrity of their recorded crime numbers, recognizing that there are bad as well as good ways of getting them down. Expectations may well differ from district to district, for some clearly face more difficult problems than do others. Percentage changes can be inappropriate when the base numbers are low. But currently the accountability process just calls for "less," or reductions compared to the previous year.

Overcoming the bureaucracy. As noted above, one goal of OMA is to involve all of its units in CAPS and problem solving, because “community policing is the way we do business.” Prior to instituting the management accountability process, however, this commitment did not extend very far beyond the department’s Patrol Division. Community policing and problem solving were not seen as something that other units did. Even within the Patrol Division, there was never a clear operational role for some managers. This changed with the advent of management accountability.

Watch commanders. Watch commanders, who hold the rank of captain while they have the position, are responsible for running the operations of the district 24 hours a day. They are the ones who assign missions and make sure they are carried out. They handle staff assignments and anything else that may come up during their shift. When their job description was revised in 2001, CAPS-related duties were included for the first time. In addition, watch commanders are expected to take an active role in making sure the district is focusing on its priority problems, by being on top of the district’s numbers and crime trends and by assigning missions that focus on these priorities. As part of the district management team, they are required to attend all accountability meetings, to be involved in problem solving and to manage the resources under their control. The expectations are evident at headquarters meetings, where watch commanders are asked direct questions about their knowledge of crime trends in the districts as well as pointed questions about their decisions. For example, for some time the deputy superintendent focused on impounding cars that could be seized because they were linked to narcotics cases. In preparing for headquarters meetings, his staff would compile a list of the cars that could have been seized. When there was a discrepancy between this list and the cars that were actually seized, he would quiz commanders or watch commanders on their judgments to make sure that seizure was being considered in each case. Many of those we interviewed consider watch commanders to be the “linchpin” in making accountability work. One manager stated: “Until captains are truly held accountable for how they manage their watches, and their feet are held to the fire, nothing will change.” The general consensus is that watch commanders are extremely involved in managing problem solving.

Special units. This group includes units and bureaus staffed by thousands of department employees. Most important in this context are Detectives; Narcotics; a Special Operations Section that provides roving bands of tactical officers; the Public Housing Unit; the Public Transportation Section; Vice Control; the Youth Division; and the School Patrol Unit. These units are not organized along district lines, and there has always been some tension between them and the patrol division. The special units have been happy to let the Patrol Division do “community policing” while they did “traditional policing.” Sometimes there was outright resentment or animosity between the divisions, but sometimes there was just lack of communication.

The management accountability process tries to break down the barriers between the different divisions in order to foster communication and collaboration among them at the operational level. Heads of the units are required to be at the headquarters meetings, and they or

their representatives are required to attend area accountability meetings. At the meetings, they are expected to respond to questions about how they have been supporting the districts in their efforts. For example, OMA staff monitor arrest patterns of Special Operations officers to ensure that they are making the right kind of arrests in the right places. Detectives are routinely quizzed about whether they have been coordinating their efforts with district priorities.

In our interviews, there was general agreement that special units have become more responsive to requests for support from the districts since the accountability process began. There has been an unprecedented increase in communication from these units, and they are providing reports and feedback to district commanders now more than ever. While some of the barriers are still there, and some are still paying lip service to the process, there has been improvement in the involvement of special units. They are being held accountable for their actions – or lack thereof – in the districts, and the districts have noticed this. One manager claimed that accountability “has pushed special units to be more responsive to [district] needs.” Another described the change in special units: “They used to go out and attack their problem. Now they attack the commander’s problem.” Not all units have bought into the concept, however. One manager noted that he is involved with some units on a regular basis while he does not see others until “10 days before the headquarters meeting.”

The Detective Division was the first of these units to be pulled into the accountability process. By most accounts, this has been a positive development. Partnerships are growing between the detectives and the districts, and information is being communicated. In addition, in spring 2002 the detectives began having their own version of accountability meetings. These meetings, established as an initiative to decrease homicides, focus on information sharing at the area level. Tactical representatives from districts in the area, as well as area units such as youth, bomb and arson, the narcotics squad and others, meet regularly to discuss unsolved homicide cases. How this fits into the overall accountability process remains to be seen, and our next report will take a closer look at developments outside of the Patrol Division.

CAPS Implementation Office. The accountability process has caused the CAPS Implementation Office (CIO) to organize more activities that support police priorities. One feature of the accountability process is that civilian CIO area coordinators were added to the district’s management teams, and they are expected to participate in district planning and evaluation efforts. CIO area coordinators and their staff of organizers, as well as city service coordinators have access to SOPs, allowing them to focus their efforts on target areas prioritized by police. In some areas CIO staffers use SOPs to write their own strategic plans. In those plans, organizers give their attention to sites noted in the SOP. This new mandate for the CIO enabled many districts to finally learn that the CIO had resources that could be poured into solving problems. CIO staff attend accountability meetings at all levels, and are called upon – especially at area and headquarters meetings – to document what they have been doing to assist the district.

DGHES. The Drug and Gang House Enforcement Section (DGHES) has played a prominent role in problem solving since its inception. The Chicago Department of Law (the

city's attorney) formed DGHES to use the city's drug and gang housing ordinance to prosecute negligent property owners. Attorneys are assigned five police districts each. They focus on crime in and around gang or drug houses, vacant lots and abandoned buildings. They use municipal code violations and crime patterns to target property owners, who are legally responsible for the physical conditions and criminal activities in and around their buildings. It was natural to have DGHES representation at headquarters meetings to discuss how their work related to SOPs. However, this did not occur until late 2001. And then the process was not always well-executed: a lawyer assigned to one area found that most buildings referred to him were not in the SOP areas. More recently, headquarters sessions have featured analyses of DGHES and other building-focused programs, and maps have been displayed linking their location with priority problems identified by the district.

Intelligence-driven policing. There is interest around the country in finding ways to link data to decisions in policing. The capacity to link efforts to hold unit managers accountable with new information technology represents a major change in the way police departments are run. In the past, computers simply stored the immense flow of data that comes into police departments, but increasingly they are flexible enough to give back needed information, in the form of analytic reports and crime maps. This is a cornerstone of the accountability process, because the flip side of crime analysis is accountability. A great deal of knowledge about what is happening in a district is now available to everyone, and others can easily see what the district has been doing about it. While information about crimes can be organized to reveal patterns, information about incidents and arrests can also be organized to reveal whether the district's actions are making an impact. The accountability process has forced managers to become crime analysts – like it or not.

In practice, usually one or two people in the district take on this responsibility; some are naturally drawn to it, especially those who are computer-savvy, while others are told to learn it. The department has observed a surge in interest in information system training among district personnel, which OMA tracks. Though the head of OMA hopes that one day “everyone in the department will be a crime analyst,” most still do not believe it to be their responsibility. Officers have always relied on others to provide information, and they continue to expect this. In addition, crime analysis is seen by many as simply more work – an additional responsibility that is not an integral part of their job. Until this attitude changes, crime analysis will continue to be viewed by most as “that's [fill in person's name, position, or rank] job.” However, it is encouraging to see examples of technology use in the districts. At one district's SOP meeting, it was mentioned how crime analysis had successfully affected the deployment of resources. One manager noted during an interview that his district appreciates that more detailed data are now available, making it easier for them to see emerging crime trends. We heard predictable complaints about too much paperwork. The accountability “paper trail” was seen as overwhelming, but equally as often it was viewed as important to document district efforts and show that something was being accomplished.

Implementing best practices. The ultimate goal of crime fighting strategies is to alleviate crime and disorder problems. This is not an easy task – if it were, these problems would not be considered “chronic” and would not persist regardless of police efforts and different strategies. Therefore, while OMA would like to see districts demonstrate measurable success at reducing crime – and indeed they do judge districts on whether their numbers have gone down or up – they also acknowledge that the police have only so much control over crime. As a result, they stress that each district should choose its problems and strategies, based on an analysis of the data, and then concentrate its resources on them. OMA asks, “You chose these strategies. Are you doing them?” If the district is using the strategies, the question then becomes, “Are they working?” The answer to this question determines the district’s future actions. If they are not working, strategies need to be discontinued and new ones put in place. But if they are working, the activities should continue. And, successful strategies should be disseminated to other districts that may be able to use them successfully as well.

Accountability meetings are a promising forum for the discussion of best practices. OMA makes a constant effort to encourage creative problem solving. A familiar refrain, especially at early meetings, was “You’ve got to think outside the box . . . we should constantly be looking at different ways to knock down the problem.” Whenever a district came up with a new approach or initiative, OMA staff and some of the senior executives would pounce on it, offer praise and talk about disseminating it as a best practice. Unfortunately, this was the exception rather than the rule. Traditional police strategies – including using the same generic strategies to deal with different problems – continue to be king.

Because only the focus district attends headquarters meetings, they are not ideal venues for disseminating best practices to other districts; area-level sessions are probably a better venue. OMA has created a Web site that includes an inventory of best practice reports, as well as district and area SOPs and beat plans. This site has been accessible since June 2002, but whether managers will seek this information remains to be seen. Currently no mechanism exists to track whether the site is being accessed. There is evidence that, to some extent, successful initiatives or strategies are being shared among managers and districts in meetings. For example, at one headquarters meeting we observed there was a discussion on what to do about retail theft. The same issue came up at a headquarters meeting a few months later, and someone encouraged this commander to contact the other district for assistance. We have also seen this in meetings at other levels. The same topic came up at an SOP meeting in a district, and the commander noted that another district had dealt with a similar problem, suggesting, “Maybe we should talk to them.” Technology promises to make dissemination of best practices more efficient.

There needs to be more attention paid to why particular strategies work well or why a district’s numbers are down. We have observed that when managers were asked why, for instance, their district’s medical absences are down, they often do not seem to know. In another example, why were thefts from autos down? Is it because flyers were put on cars reminding owners not to make their car a target? Or is it because an offender was recently arrested? Or is it because a snowstorm stranded everyone for a week? Many of the explanations that we hear

reflect after-the-fact guesses rather than thought-out analyses. Care must be taken in disseminating something without a firm understanding of why it should work in various settings.

Measuring what matters. Both the districts and OMA focus on crime statistics – numbers of incidents, arrests and calls for service – to determine whether something is a problem and whether the problem is getting any better. The renewed focus on reducing chronic crime and disorder inevitably presses the organization toward reliance on those numbers. Even while they acknowledge that keeping track of numbers is necessary, managers in the field note that they undervalue the “intangibles” that were community policing’s hallmark, including community satisfaction and the formation of police-community partnerships. Some lamented that accountability was forcing them to stray from the CAPS concept. One argued, “When CAPS started, it wasn’t supposed to be this numbers thing, and now it’s totally a numbers thing.” Another critic noted, “[Accountability is] not CAPS. This is a left hand turn from CAPS. . . This is mission-oriented policing, more traditional. . . This is top-down management, stats driven.” A minority approved of the emphasis on numbers, believing that having to explain them provided an unbiased standard for holding managers accountable.

This perception that accountability is “not CAPS” runs counter to the OMA position that accountability supports CAPS. The director has argued several times that “CAPS is problem solving, and problem solving is CAPS.” We are less convinced of this formulation of what CAPS represents. From the beginning, CAPS stressed the role of an active and engaged citizenry in attacking problems, and an expansion of the police mandate to encompass a much broader array of neighborhood problems and conditions, working in collaboration with a broad range of city and private agencies. By this definition, some of what matters is not being measured, and thus eludes the accountability process. The process is driven principally by objectives that can be measured by the department’s information systems. Community policing has a number of objectives – including some set out in the CPD’s 1993 mission statement, *Together We Can* – for which there is no data to assess either the success of the organization or the effectiveness of mid-level managers. Two such objectives are reducing fear of crime and enhancing customer service. Except for monitoring attendance numbers at meetings and police-sponsored events, little is monitored. At headquarters sessions, the citizen role in problem solving has been reduced to participating in CIO-organized marches, DAC activities and court advocacy; otherwise, this is a police-only program. Direct community input is rare at accountability meetings at all levels.

As noted above, the representation of community concerns in the accountability process is inadequate. OMA has few sources of information about these, and what they have provides an unreliable guide to residents’ priorities. At meetings, the time devoted to community concerns is slight. Sometimes a community representative – usually the DAC chair or court advocacy chair – is present at these meetings, but not to represent any views. Once, a manager joked about how he got in trouble for putting a community member on the spot by asking a question. Only on occasion does the area coordinator from the CAPS Implementation Office have a role. OMA has often said when discussing strategies that “this process is not just about the police. We need to consider community and city service strategies.” If the community side of things is as important

as it is made out to be, more time and attention need to be given to learning what community concerns are and what strategies might involve the community more in problem solving.

Rewards and performance. Time after time in our interviews, we heard from managers that they do not perceive that rewards and consequences come from the department's new accountability process. In order for this process to be credible, districts need to be rewarded for doing a good job – not just for doing their job – and they need to be disciplined when they are doing a poor job. According to department executives, district managers have been removed because of their performance, but this is not visible to many we interviewed. They continue to believe that, at best, the only reward is pride in a job well done, and they are frustrated that their efforts are not rewarded, while others who do not put in the effort suffer no consequences. There is no visible “grading” of districts on the basis of their area or headquarters sessions. Currently, the only apparent penalty for not doing well is losing face. This is not trivial – many note that no commander wants to be embarrassed by performing poorly in front of superiors and his or her own management staff. But except for the occasional “kudos,” or “I congratulate you,” there is no other apparent feedback. One manager who viewed the process favorably but felt there should be clearer performance standards noted:

He doesn't see accolades other than “You did a nice job.” It comes down to personal pride. “There are seven of us on parade when these things come up. It's like school: we want to have the answers when questions come up.”

Commanders who busted their ass to do it would say privately, “I'm doing it for pride,” but they know others who don't work as hard won't get consequences. The credibility of the process isn't there.

This may have been appropriate during the first round of the headquarters accountability process, which took 15 months. During this period, OMA was deeply committed to educating everyone about the new process, as well about supervision and evaluation. As the novelty wears off, the lack of clear incentives can threaten to turn the sessions – especially at the district and even at the area level, where the process is not under close scrutiny from downtown – into “going through the motions meetings,” which on this scale would be at great cost in terms of the time devoted to them by management.

Not everyone in the organization fears a somewhat tougher stance. In a discussion with one senior manager, the discussion moved to consequences, and the interviewer noted:

[The informant] believed that people should get fired if they're not getting results, because that's what they're there for. It's not personal; it's fair. Managers need to know where the problems are, if the solutions are getting done and how they know they're getting done.

It is also possible that personnel changes have resulted from the accountability process. Some of our informants argue vigorously that unit commanders and area deputy chief-level staff have been removed because the process confirmed that they were not running their operations effectively. Others may have been reassigned or encouraged to retire for the same reason.

Institutionalizing change. Support for the accountability process seems strong among those who are actually involved in it: area and district executives, and members of district management teams. Some have indicated that they cannot imagine the department doing without it. A commander noted:

“It keeps everyone on their toes,” and is a “much tougher, but better, way to do business. I can’t imagine going back [to the old way]. Accountability will be one of the superintendent’s lasting accomplishments.”

OMA is now part of the formal structure of the police department, its status defined by a departmental general order. That being said, there are those who have been discomfited by the process, for districts and special units have been accustomed to operating with little administrative scrutiny as long as nothing was obviously wrong. Some have objected to the diversion of field resources to handle administrative tasks increasingly associated with the demands of CAPS implementation and OMA pressure. Because the place of a formalized accountability process in the department is not solidified, members who are discomfited by the new pressure to meet measurable performance standards can hope that it might wither away in future administrations. The need to stay the course across administrations and directorships is highlighted by the special difficulty of changing the culture of a police organization. OMA has embarked upon developing “a culture of accountability” within the CPD, and that takes time and focus from top management. Accountability is intended to become a routine feature of the department. However, it will not be enough to label boxes and arrows on the organization’s chart; senior managers throughout the city will have to believe in the process and struggle to make it work. It must become part of the agency’s regular way of doing business.

Strengthening Community Policing through Information Technology

The Chicago Police Department, in partnership with Oracle Corporation and the Police Executive Research Forum, is developing a state-of-the-art integrated criminal justice information system. This new system – Citizen Law Enforcement Analysis and Reporting (CLEAR) – is a natural progression in the CPD’s ongoing quest to “police smarter.” The department’s strategic vision for the future, *Together We Can*, named the use of technology as a component of change. In the document, the CPD set forth its commitment to integrating new technology to support the broader goals of CAPS – “enhancing our crime-fighting capacity, improving the quality of neighborhood life and developing a strong partnership with the community.” This section of the report describes this new initiative and examines some of the “launch procedures” that lie behind it.

Information Technology and the Police

We begin by noting the national context in which CLEAR is being launched. The information technology (IT) revolution, although it started a half century ago, is just beginning to explode in the criminal justice world (see Coldren, 1996; Dunworth, 2000, for reviews). Police departments, in particular, are ripe for change, as they are positioned to utilize information technology to guide daily operations, analyze the effectiveness of tactics and enhance management accountability. The CompStat system in New York (McDonald, 2000), as well as data-driven law enforcement programs such as the Strategic Approaches to Community Safety Initiative (SACSI) (Coldren, et al, 2000), have given police a taste of what is possible. Unfortunately, as Dunworth (2000) notes, “the present reality is that too few police departments are utilizing that capability effectively” (p. 371). Police agencies the size of Chicago are awash with data. Each day they receive thousands of 911 calls, complete more than a thousand crime reports and arrest hundreds of people. However, although they enter thousands of data elements into their databases each day, it has been of little value because it cannot be extracted for reports and analyses.

Today, “data-driven policing” is the buzz in law enforcement circles. Interest is driven in part by external demands for accountability, cost-effectiveness, staff “right-sizing,” performance measurement, and audits of their probity and procedural regularity (Chan, 2001). Police have also observed the impact of IT on internal “business processes” in the private sector – lower record keeping costs, greater flexibility and speed in decision making, better management control over product quality and more individualized relations with customers. They have also observed that the required computer hardware and software has become less expensive and more “user- friendly.” Many police agencies want to get involved and showcase new mission statements, business and marketing plans, and training programs that focus on information technology. However, too often there has been more talk than progress in implementing integrated data systems, the National Incident-Based Reporting System (NIBRS), partnerships with researchers, and crime analysis and forecasting.

The CPD has a large-scale plan for harnessing the power of information technology. Beginning in June 2001, the CPD, with more than \$35 million in support from Oracle Corporation and other funding sources, began an intense program of software development and testing. Oracle, a major business software designer, wants to demonstrate that recent advances in information systems can be tailored to help foster greater accountability, efficiency and effectiveness in the public sector arena. Oracle assigned more than 20 software developers to work on this project. The CPD's superintendent and deputies have made CLEAR a top organizational priority. Given this level of commitment and expertise from the participants, CPD management anticipates that IT will have a substantial impact on the department, and ultimately on the community it serves.

A review of the recent (25-year) history of automation projects in law enforcement reveals a glaring paucity of research examining the impact of these interventions on police organizations, bureaus or units and line officers. Despite the absence of good research on many topics, it is clear that automation in law enforcement has traveled a rocky road. Whether we look at records management systems, criminal histories, computer-aided dispatch, emergency response systems, crime analysis, Uniform Crime Reports (UCR) and NIBRS, the Internet, or systems integration and networking, most police departments have not yet adequately utilized the capability inherent in information technology. The list of reasons for this is long. With crime analysis, for example, obstacles to success include: the use of isolated individuals (usually civilians with limited knowledge of officer needs) to provide statistics to district personnel rather than encouraging widespread data analysis among supervisors and line officers; hardware and software problems; poor quality police data (missing or inaccurate information); insufficient funding for completing projects; inadequate training; and the attitude among police personnel that crime analysis is not needed for their job (Dunworth, 2000; Reuland, 1997). Often crime analysis is a special project that does not involve line officers in examining data and pays little attention to whether the product is actually used in the field.

In general, our experience tells us that good ideas, good people and good technology are critical to making automation projects work effectively, but they are not sufficient to ensure success. Agencies consistently underestimate the human factors (individual, social and organizational influences) involved in implementing new initiatives – especially technology. Real people are involved, and they must interface with the equipment and software. These individuals must understand 1) what is expected of them; 2) how changing their behavior will benefit them personally and make their jobs easier; 3) how easy it will be to change their behavior with proper training, user-friendly programs, technical assistance, etc.; and 4) how these new systems will change the way their performance is evaluated. Instilling positive attitudes and expectations is important, but IT can be structured to produce results among the most reluctant employees. As Chan (2001) notes, systems with required fields, drop-down option lists and other quality-assurance mechanisms make it difficult for officers to bypass data fields, thus producing more frequent and thorough reporting.

The CPD is well aware of the many obstacles confronting previous data systems projects, and has plans to overcome them. Department managers plan to introduce new systems and processes that will impact everyone in the organization – from the way officers do their jobs daily, to the administration and management of the agency as a whole. CLEAR will go well beyond New York City’s CompStat in providing accountability and monitoring of productivity at the unit and district levels. Equally important, CLEAR intends to reach beyond the organization to involve the community. As police organizations continue to redefine themselves in the era of community policing, understanding the consequences of new police capabilities for community residents becomes vitally important.

Origins of CLEAR

It is useful to understand the context under which the CLEAR project evolved. Oracle had been working with the CPD since 1996 on development of the Criminal History Record Inventory System (CHRIS), as well as on other information technology projects. CHRIS, in its initial release, had many limitations and was not well received by users. One complaint was typical of the reception of IT applications in many police agencies: officers labored to put information in, but got nothing back in return. It was a system that provided information to “the bureaucrats” rather than to field personnel. Detectives in particular complained that they were spending a great deal of time inputting data while not getting anything useful. CHRIS needed reworking, and the CPD believed the best way to accomplish this was to develop a menu-driven application.

When the CPD decided to “roll up its sleeves” and overhaul its information technology systems, it approached Oracle Corporation to present the concepts behind what would become known as CLEAR. At a spring 2001 Oracle/CPD meeting, the department described CLEAR’s potential market value and reasons why Oracle would be the CPD’s best partner for developing an enterprise system for law enforcement. Among the several points presented by the CPD were: 1) Oracle would have full access to CPD operations; 2) the CPD would have ownership of its proprietary version; 3) Oracle would have ownership over the generic version, which could be marketed to other law enforcement agencies; and 4) the department would support the partnership with in-kind services such as development staff, command staff and overhead. Additionally, both Chicago’s police superintendent and the chief of Washington, DC’s Metropolitan Police Department were present to show that there was “multi-city interest” in such a project.

Within a week of the meeting, the CPD and Oracle were engaged in continuing dialog about CLEAR development. Underscoring Oracle’s enthusiasm about the project was its offer of funds for development purposes. However, the offer came with one stipulation: the project had to be contracted out by May 31, 2001 – a date fast approaching. At the same time, a CPD deputy superintendent contacted the Police Executive Research Forum (PERF) to gauge its interest in partnering with the CPD to assemble a portrait of best practices in the IT field and to educate

other law enforcement agencies about CLEAR and IT. PERF showed immediate interest in the CLEAR project's ideas and its proposed role.

A second meeting took place between the CPD and Oracle's first vice president. The negotiation began with Oracle's offer of 90,000 consulting hours for CLEAR project development. After ensuing discussion about the project's need to be "capacity building," Oracle added 500 hours of Oracle University training for CPD staff. The CPD reciprocated with an offer of \$9 million from the Office of Community Oriented Policing Services (OCOPS) funding that had been allocated for technology. As the project approached the \$40 million mark, a law firm was hired to handle the contract negotiation process. With City Hall's help in the contract process, the agreement was completed in seven days, including several sleepless nights for CPD and Oracle staff.

Description of CLEAR

It is important to note that CLEAR is not a static system, but rather an evolving one that is open to feedback, refinement and redefinition when necessary. Each application within CLEAR undergoes a multi-stage development process involving conceptualization, joint application development (JAD) sessions between developers and police, subcontract negotiation when necessary, pilot testing and training. Applications are implemented only after focus groups have offered feedback about their usefulness; after internal marketing has taken place to elicit user interest and buy-in; and after field testing has determined that the application will work properly. If there are difficulties at any of these stages, the application team works out the problem before the application is made available in the field. Target implementation dates are set for the various CLEAR applications, but they are often adjusted when unanticipated issues arise. A major goal of CLEAR is to help users understand that the automation process has the potential to enhance their jobs, as opposed to viewing new procedures as another set of tasks being added to their already long list of "things to do."

The primary goal of CLEAR, in partnership with Oracle and PERF, is to design and build an enterprise information system – customized for the CPD, but adaptable for others – to fundamentally change the way criminal justice agencies conduct business. The three major CLEAR components are police management, criminal justice integration and community/business partnership. The goals for each include:

Police management: Promote effective resource allocation; officer management and accountability; risk management and early warning; tactical and strategic planning; and fiscal accountability. The departmentwide management accountability process will make use of the new systems to address crime and disorder problems; react to emerging crime; optimize community involvement; and manage available human and material resources.

Criminal justice integration: Enable unified strategies to reduce crime; eliminate criminal justice bottlenecks; increase accountability between criminal justice agencies; and

provide a comprehensive picture of offender activity. Information sharing will involve other law enforcement agencies, prosecutors, the court system, the corrections system and other interventions, perhaps including non-criminal justice partnerships. The CPD has stated that it hopes the criminal justice integration component will give the CPD the capacity to “police smarter”; enhance partnerships with surrounding suburbs and cities; improve the quality of criminal justice information; improve employee morale; and reduce liability costs.

Community/business partnership: Strengthen problem-solving capacity, conduct community-needs assessment; and allow for easy and convenient information sharing and intelligence gathering from the community. Currently the CPD partners with citizens through monthly beat community meetings and through District Advisory Committees in each of the 25 districts. There will be increased effort to reach people currently not participating in these activities as well as an increased focus on meaningful problem solving and citizen involvement at beat community meetings.

In sum, CLEAR attributes include predictive resource allocation to deploy officers when and where needed; unprecedented availability of information for management analysis and officer accountability; shared problem-solving information for community policing partners; pre-packaged information to support decision making at all levels of the department; and provision of information integration to manage offender flow through the criminal justice system. When CLEAR is fully deployed, the CPD expects to enjoy reduced crime and safer communities; proactive community involvement; proactive resource allocation; decreased redundancy in administrative functions; and increased management and officer accountability. The various CLEAR applications will be available through the intranet at the CPD, the internet for the public, and the extranet for other government agencies.

Figure 19 lists 11 CLEAR applications currently under development, as well as four CLEAR-related projects whose development and execution are integral to maximizing CLEAR’s potential. Also shown are four applications that remain at the conceptual stage. The following subsections of this report will provide an overview of active CLEAR applications and related projects, and briefly describe planned applications. A final subsection presents some research findings on the Chicago community’s interest and readiness to strengthen its partnership with the Chicago Police Department through information technology, and on officer and civilian personnel attitudes and use of technology.

Information in this section was derived from 48 in-depth face-to-face interviews with application developers, trainers, implementors and users; from 25 observations of focus groups, training sessions, pilot tests, meetings and application launches; and from resident survey data collected at beat community meetings. Our data collection began in November 2001 and continued through November 2002. This report represents the most up-to-date information at the close of our data collection period. Funding for the continued study of CLEAR has been secured; findings will appear in a later report.

CLEAR Applications and the Development Process

For the reader's clarity, listed below are applications comprising the CLEAR enterprise system, as well as projects undertaken to complement or enhance it. More detailed descriptions of each application and project are found in later portions of this section.

Active CLEAR applications at various stages of development:

- Automated Incident Reporting Application (AIRA)
- Arrest System Phase II
- Data Warehouse
- Digital Mug Shot System
- eTrack Phase I
- Gang Module
- Crime Mapping
- Juvenile Arrest Application
- Organized Crime System
- Personnel Suite
- Traffic Crash Report Routing System

Adjunct CLEAR projects:

- CHRIS Hyper Text Markup Language (HTML) Conversion
- Criminal Justice Integration Project
- National Incident-Based Reporting System (NIBRS) Compliance
- Technical Management System

Applications slated for future development:

- Automated Pawn Shop
- Community/Business Partnership
- Enhanced Hot Desk
- Probation/Parole Information Integration

Figure 19

CLEAR Module / Project Status*

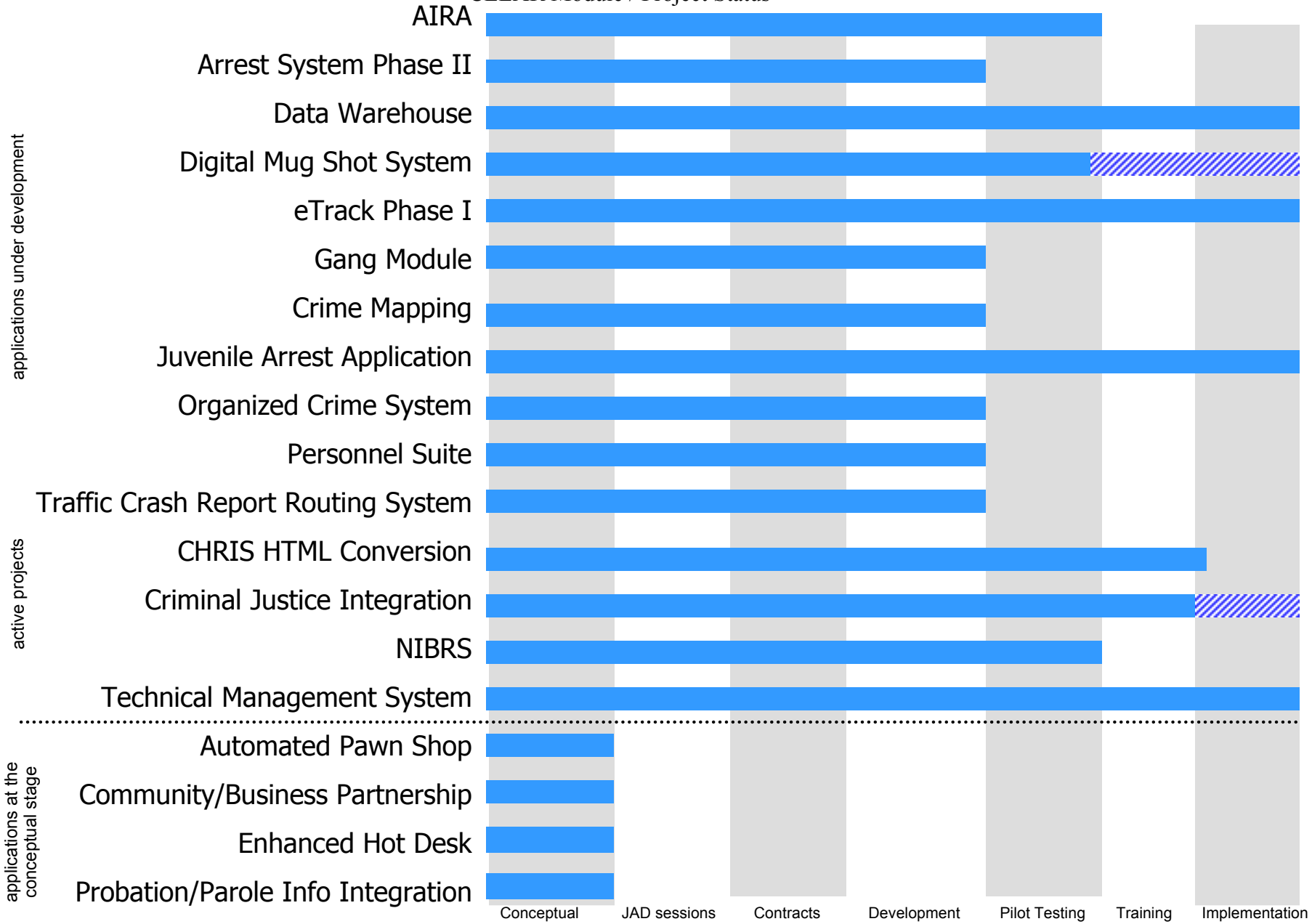

*not all modules and projects pass through each stage

//// indicates partial completion

The Development Process

An application can pass through seven stages before being launched: 1) conceptual, 2) joint application development (JAD) sessions, 3) subcontracting, 4) development, 5) pilot-testing, 6) training, and 7) implementation.

At the **conceptual** stage, a module exists only as an idea that either allows for a more efficient and cost-effective means for accomplishing a CPD core function or enables the department to use data to engage in a wider scope of law enforcement strategies.

Each system being developed undergoes a series of day-long **joint application development (JAD) sessions**, often held over a period of several months and consisting of high-, mid- and low-level meetings. At these working sessions, people from the division for which the application is being developed – the eventual users – provide their knowledge of their unit’s business operations. After each session, the Oracle team produces a process flow document, an example of which is shown in Figure 20. Flow documents are based on procedural information gleaned from the day’s activities, and they are reviewed at the next meeting. After three or four JAD sessions, a process model is drawn by the Oracle team and given to the division’s key personnel. After the unit or division management team carefully reviews and accepts the document, it becomes the foundation for the application’s development.

A number of applications under development require **subcontracting** with outside vendors to create or supply hardware or software for the various systems. The city’s bidding process must be followed, usually necessitating proposals from several vendors. This process can hold up the development of an application, particularly if there are protracted negotiations about a contract’s language. And, occasionally vendors realize that they cannot deliver the promised product, and the CPD must begin anew, further delaying the module’s development.

Applications in the **development** stage have progressed from a concept, with appropriate input, to a “ready for testing” mode. Usually Oracle development team members and CPD members have worked together on different aspects of the application to get to this stage. A significant outcome of this stage is the identification and detection of flaws and unexpected outcomes. Solutions are undertaken by the developers and additional input may be sought from potential users.

The **pilot-testing** stage is next and is conducted in a number of ways. Pilot-testing can be conducted at CPD headquarters, at a select stationhouse site, in a particular unit of the department, or at the district-level involving many officers and their supervisors. The type of pilot-testing used depends upon the complexity of the application and the targeted user of the application. Pilot-testing may be completed in one day or over the span of a longer period. The test period is generally based on the complexity of the application and the number of users impacted by its implementation. At this stage, unanticipated problems or additional feedback can send developers back for fine-tuning of the application.

Figure 20
Tuition Reimbursement Process Flow

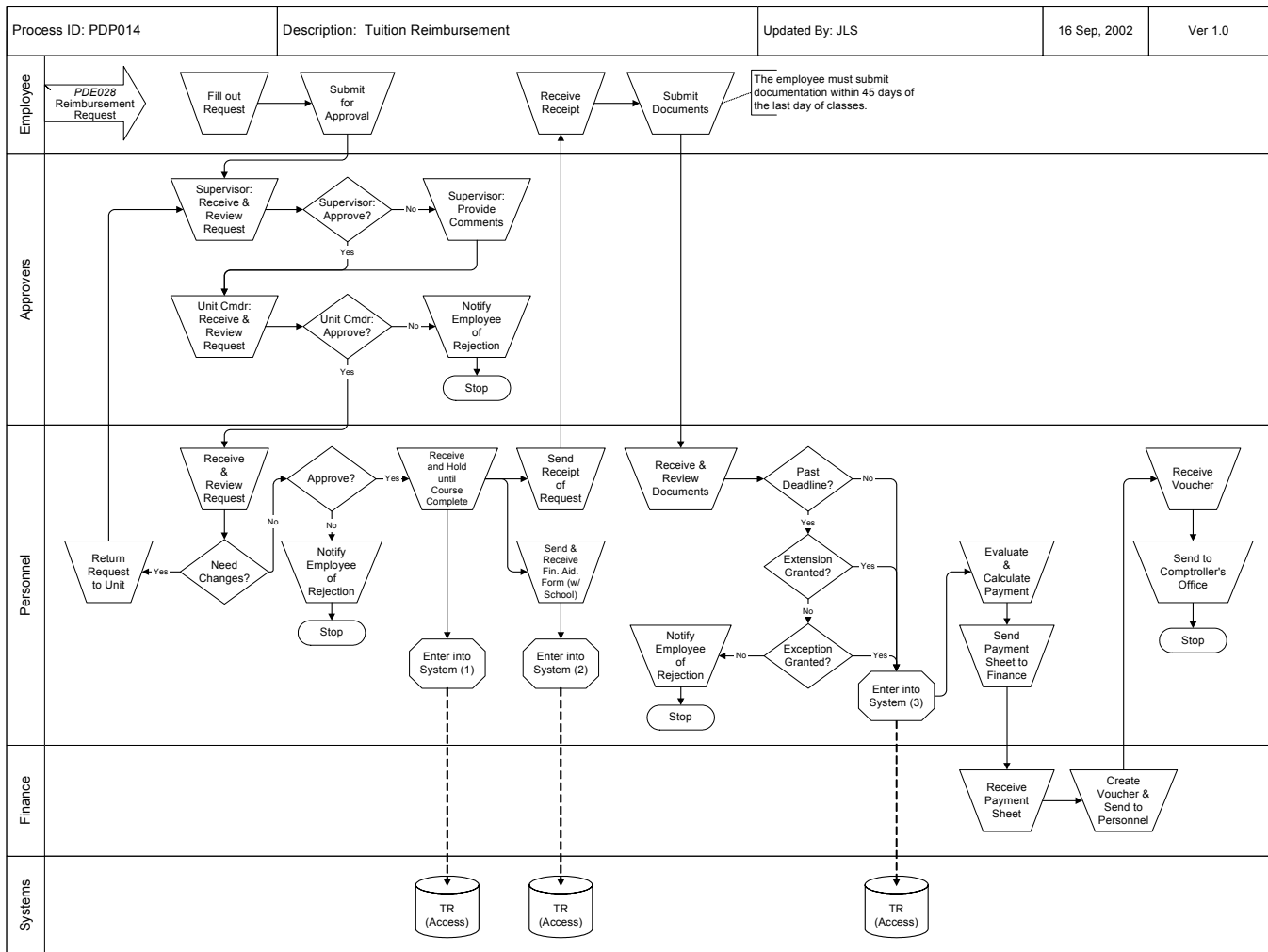

Training also takes numerous forms, depending upon the complexity of the application and the number of potential users. Applications that are simply enhancements of existing systems may require nothing more than widely distributed explanatory memos or brief explanations and streaming video presentations at roll call. (Streaming videos are on-demand presentations stored on a network and can be viewed at any time in multiple locations.) Applications that are replacements of outdated and antiquated systems or that are entirely new modules require more intensive training and continued technical support. For such applications, trainers may spend several days out in the stationhouse providing individualized instruction to field officers. A training method known as “train the trainers” is often used at the CPD for large-scale instruction. For this, designated district officers receive training on use of an application, and they

subsequently return to their units to train fellow officers. The CPD has created a special training team whose primary responsibility is to make sure that users of each CLEAR application are adequately familiarized with the module either prior to or at the time it is implemented.

When an application reaches the **implementation** stage, just about all the bugs have been worked out, and it should be technically unflawed. The challenge at this stage is to create excitement and motivation among potential users in the environment where the application will be accepted. Users must be convinced that the new application will help them do their job more expeditiously. Support must be in place to work through early resistance and to get users through the technical learning curve. We know the least about this stage, as most applications are not yet fully operational. During 2003, many of the applications will reach this stage, and we will later report on their impact on the organization and its users.

Applications Under Development

Automated Incident Reporting

The CPD's case reporting system is becoming computerized by a CLEAR module known as AIRA (Automated Incident Reporting Application). Once implemented, AIRA will enable Patrol Division officers – the backbone of the organization – to complete case reports via portable data terminals (PDTs) or workstations in any CPD facility. AIRA development is a very ambitious project with roots dating back several years; over its gestation period, its scope, depth and timeline have increased almost exponentially.

Background

In March 2000 a lieutenant in the department's Research and Development unit was charged with creating a basic, user-friendly data entry system to be used by patrol officers to complete incident reports. The new project manager recruited five police officers, both with and without technical knowledge, to work over a five-month period to develop the business logic for such an application. They were then to hand it over to a vendor for technical development. A few months into the effort, the project manager was promoted, and he subsequently turned over responsibility for the project to a sergeant, one of the five officers who had been working to develop the application's logic. The lieutenant's promotion left the team with a gap in technical know-how, and over the next few months, a series of assignment shifts decimated the team, leaving the project manager to handle the task single-handedly. The lone AIRA developer realized that the project had been "put on the back burner," evidenced by the fact that the only support staff available to him consisted of interns from a nearby university and that funding for the project had become quite limited. Development limped along for several more months, until an administrator was brought in to head up a new unit called Information and Strategic Services to see the development of CLEAR to fruition.

Goals for AIRA

The department's goals for automated case reporting are several and well-defined. AIRA is expected to simplify the reporting process; improve reporting accuracy, quality and completeness; free supervisory personnel from reviewing report minutiae; provide follow-up investigators with complete and timely information to improve case solvability; reduce the number of hours tied to report processing; and achieve NIBRS compliance (explained fully in another section of this report). As part of the CLEAR enterprise system, AIRA is also expected to interface with the department's other key information applications and systems. As the first-line information collection system – the “on ramp” to CLEAR – it must successfully interface with all of the other modules, receive information from the dispatch system and transmit data to the data warehouse and to CHRIS (which will soon become a part of CLEAR).

Development and Implementation

Development of this CLEAR module differed from that of the others. As mentioned previously, the development team originally worked on the business logic aspect of the application with the idea of eventually turning the project over to a technical team to realize it. However, when the project was resurrected in summer 2001, despite the fact that Oracle developers were already beginning to work on several CLEAR modules, AIRA remained an in-house project. Two officers with programming expertise joined the project manager, and AIRA began to take shape. Soon thereafter, another officer was brought on, chosen for her knowledge and experience with process mapping, a method that, by means of flow charts, describes, analyzes and ultimately improves organizational operations. Flow charts were created to ensure that data input screens capturing the rich data needed for crime analysis were developed for every type of incident. Over the ensuing weeks, five officers from the district where AIRA pilot testing was to eventually take place were brought in to work with the AIRA team to provide insight and expertise of officers with current field experience.

Because AIRA was not being developed by Oracle, formal JAD sessions were not held, but focus groups have regularly contributed to the application. Randomly selected tactical, beat, lockup and rapid response officers were brought together in three different groups to meet twice monthly for three months. In addition, four groups of captains and lieutenants were convened to offer suggestions about the application after seeing a demonstration. According to the development team, many members of each group were skeptical at the start of the process, but most left with positive attitudes about the application. These groups were also encouraged to complete a survey eliciting their opinions, suggestions and concerns about AIRA implementation, and were directed to an intranet site to do so. Other sources of input included officers from the Missing Persons unit to ensure that appropriate information for these types of cases is included on AIRA; assistant state's attorneys, who provided their opinions about the printed case report produced by AIRA; and CPD management, who attended periodic demonstrations of the automated case reporting module.

During this process, a member of the team reviewed the various general orders – the official department documents that delineate new rules, procedures or policies, as well as procedures for implementation and measurements of accountability – that would be affected by AIRA and worked with individuals in R&D responsible for rewriting them. The officer also proposed the elimination of various procedures that, in practice, are not carried out despite being specified in the orders. More than 30 department general orders were affected by the development of automated case reporting.

Generally, reaching this point in the development of a CLEAR application would mean that after a period of pilot testing and training, the application would be ready to launch. However, this is not the case for AIRA because of the many systems with which it must interface, as shown in Figure 21. In addition to needing to install a new operating system in each of the department’s portable data terminals (PDTs), complex adaptations would still need to be made to the city’s automated dispatch system, and message-oriented middleware – software that connects two otherwise separate applications – would need to be designed to serve as an interface between AIRA and CHRIS.

Figure 21
Proposed AIRA Message Switching System

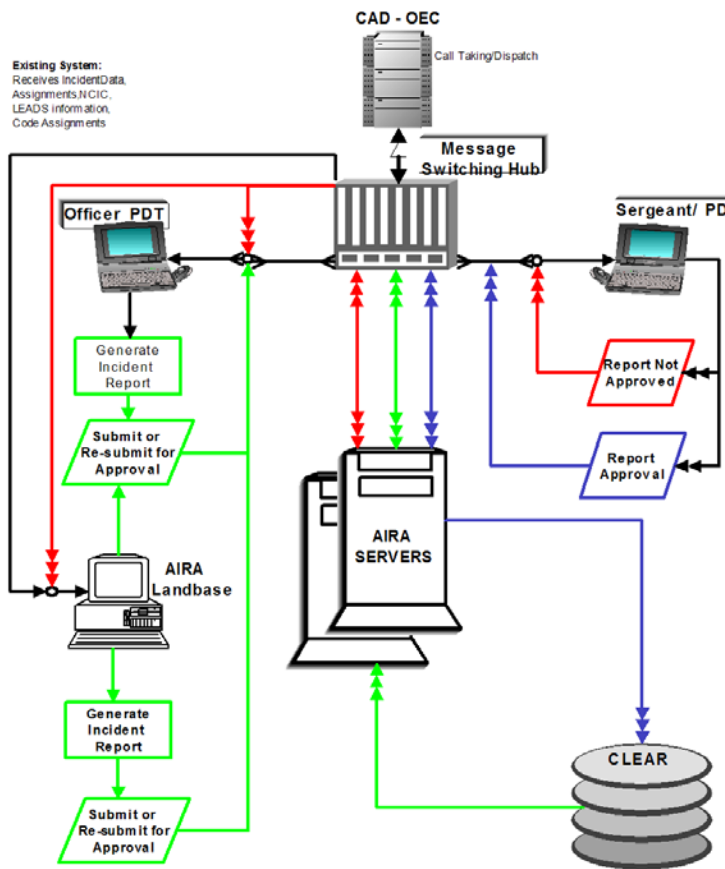

Vendors were sought for these projects, and though it was eventually decided that the original vendor for the automated dispatch system would make the changes, much wrangling ensued between the vendor and the city's legal department over the contract's language. After looking for a vendor to design the message-oriented middleware and realizing that an outside firm might take up to a year to complete it, the recently hired Data Systems director of development decided to develop the middleware in-house. While this was underway, a Data Systems project manager was working with an AIRA team member on a massive mapping project to document the CHRIS structural changes needed to accommodate AIRA data.

Field testing of the automated case reporting application was underway by early February 2002 to see what problems emerged in practice and to find flaws in the logic. At first, several cars with AIRA-equipped PDTs answered calls in the district where the application was to be rolled out first. The AIRA project manager addressed roll calls prior to sending the cars out to provide an overview of the application and to let officers know that additional cars would be joining them on district streets that evening. After a few weeks, a group of 10 to 12 officers, composed of AIRA team members and Data Systems trainers, began testing the application in a different district each week to observe the application's behavior in the city's various radio dispatch zones. Generally three officers manned the cars, with one officer taking reports through the AIRA system, one taking reports on paper and one documenting what was happening with each process. As of mid-May, while AIRA team members were testing the application while patrolling the streets, field testing was also being done with that district's stationhouse at the front desk. The station-bound AIRA tester worked with district officers to familiarize them with the new application by using it to complete "walk-in" reports.

Various problems were encountered in field testing. Perhaps most troublesome was the limited battery life of the PDTs. Despite numerous promises from various vendors that their products would offer lengthier usage periods between charges, none offered substantial improvement. Batteries that hold the charge longer than those currently in the department's PDTs are available, but they do not work in temperatures below 15°F, making them an impractical choice for Chicago's climate. Other problems included screens that did not appear during the report-taking process, occasional system "crashes" and scattered "dead spots" – areas within a radio zone where dispatches are not received. Also vexing are some PDT issues. In addition to being particularly bulky to carry around, the placement of the PDTs in the squad cars is problematic; they are difficult to see in daylight and at all times are inconveniently situated for ease of data input. This problem remains a challenge, because the mount apparatus can not be moved due to air bag compliance issues.

The complexity and sophistication of the AIRA project continued to increase, and the decision was made to bring in professional programmers, who were onsite by mid-April 2002. Within a month, another key decision was made – to change AIRA's platform from active server pages (ASP) to extensible markup language (XML), an operating system that became an industry standard during the course of AIRA's development. XML provides the CPD with greater ease in making future programming modifications. This platform change, however, delayed pilot testing in the test district once more.

As it turned out, the delay caused by conversion to XML was immaterial; disagreements over contract details between the vendor and the city's legal department prevented changes to the city's automated dispatch system from being implemented when expected, and then the vendor continually revised its timeline. As of the writing of this report, completion of the dispatch system work was scheduled for January 2003, with pilot district testing planned for March 2003.

Implementation of automated incident reporting in Chicago still faces several significant challenges – bandwidth capacity, the magnitude of training and facilities limitations.

Bandwidth. A question that may be unanswerable until citywide implementation is underway is whether the narrowband spectrum assigned to public safety agencies can adequately accommodate a large-scale wireless communication system such as AIRA. One AIRA team member stated the problem in very understandable terms: “home dial-up modems are 56K. Well, what we're dealing with is only 9K, and the pipe is small.” The development team is doing what it can to hold to a minimum the amount of data the system will be handling at any given time – for example, much planning has gone into determining the least amount of time that a report can effectively remain available via the PDTs before being transmitted to CHRIS (which will soon be incorporated into CLEAR).

An experimental wideband communications system exists that might be a solution to the department's limited bandwidth, and the AIRA team has been trying to set up a pilot test in one of the CPD's 25 districts. Known as Greenhouse, this technology would increase bandwidth from 9.6K bit/sec to 460K bit/sec, ample for transmitting incident report data as well as for wireless transmission of mug shots, live audio and video, driver's license photos and other data that would be of assistance to officers in the field. Greenhouse has performed successfully for a Florida jurisdiction whose force size and topography are not comparable to Chicago's. Consequently, the vendor agreed to set up a test site in the city, but at the time of this report's writing, full scale testing had not gotten underway because of a contract delay in the city's law department.

Successful results with Greenhouse technology in Chicago's urban setting will not provide a quick solution to the bandwidth problem, however. The FCC, which regulates and licenses radio spectrum use, has not issued a permanent license for Greenhouse, nor has it announced any intention to allocate this wideband spectrum for use by wireless communication systems, making it unwise for the CPD to invest in such technology. The department must proceed as though Greenhouse may never happen.

Implementation plans currently call for a “soft rollout,” meaning that the automated incident reporting application first will be introduced on one watch in one sector of a geographically small district. When AIRA is determined to be operating effectively in that milieu, additional sectors and watches will begin using AIRA. Once all officers in an entire district are successfully completing automated case reports, another district – probably one sharing the pilot district's radio zone – will begin the step-by-step deployment process. In addition to ensuring that sufficient attention is given to training and equipment issues, this

paradigm will allow the AIRA team to precisely identify the point at which the bandwidth is overwhelmed, should that happen.

Training. Large-scale training for the entire Patrol Division on a totally new system is a herculean feat. Nearly 10,000 people must learn to manipulate a new computer program to perform key functions with as little disruption as possible to the districts' daily operations – without overtime. Two days of training is anticipated for use of AIRA because of the importance of accurate case reporting, combined with the expanded data collection and new technology associated with the new application. No more than two officers will likely be pulled off the street at any time; this implies that training will be underway for nearly a year.

The training venue has not yet been finalized. It has been deemed preferable for officers to be outside of the stationhouse while being trained; however, there is very little enthusiasm for holding training at CPD's academy. Under consideration instead is holding training in Area headquarters' auditoriums, which would allow for more officers being trained at one time (two officers from the five districts comprising the Area in this training configuration). However the effectiveness of training officers for an application they may not be using for several months is questionable. Another possibility entails a mobile classroom that can be parked outside the district stationhouse, eliminating travel time for officers while still removing them from the distractions of stationhouse activity. Logistical challenges caused by training needs are but one example of the problems created by the sheer size of the city's police department.

Because training is key to AIRA's success, a sergeant was brought on to the development team to develop AIRA modules for in-service and new recruit training and to work with the Data Systems training team to identify the most effective instruction-delivery option for field training. A recently formed committee joining representatives of the training academy, Data Systems trainers and the AIRA team meets on a regular basis to share ideas and coordinate efforts. Also, the sergeant is currently working with interns from a nearby university to create an AIRA user guide.

Facilities. As is the case with deployment of any CPD program requiring new equipment or workstations for district personnel, facility limitations loom large. The CPD's 25 district stations roughly fall into three categories: new, modern and very old. Accommodating needed wiring and workstations is not a problem for the department's newest stations, and the modern facilities generally pose no major challenge. However, approximately one-third of the city's district stationhouses are antiquated – some even unable to accommodate new wiring for additional fax lines.

There are plans to replace many of these old facilities; however, some potentially will not be ready when it would be logical to launch AIRA there. There are both old and new stations in each police Area, and undoubtedly at least a few old and new stations share radio zones.

Infrastructure surveys were conducted during July 2002 to gauge the preparedness of each facility for the upcoming implementations. Members of the AIRA team visited each district

station, looking room by room to assess its needs, checking for ample space for additional computers and to verify whether the stationhouse has adequate wiring and data port terminals (internet conductivity ports). Not surprisingly, this effort revealed that the oldest stations would need a considerable amount of rewiring, data port installation and minor remodeling for housing new hardware. Each facility, old or new, needs additional computers.

The Future of AIRA

As explained above, AIRA is on the brink of pilot testing. The various application refocuses and delays proved helpful in at least one important way – between the time the pilot rollout was originally planned and when it will actually take place, the pilot district's new facility was completed, circumventing any wiring or space problems. Still unknown is the effectiveness of the modifications made to the city's dispatch system and the ability of the 9.6K bit/sec bandwidth to transmit the significant amount of AIRA data that must bounce between patrol cars, supervisors' cars and CHRIS. If the current bandwidth is able to run AIRA departmentwide, and a battery with sufficient power is located, work on AIRA for the foreseeable future will probably entail enhancements until either a wideband system becomes the standard or radio modem technology becomes more reliable.

Nonetheless, the work done by the now 12-member AIRA team in seeking out emerging communication technologies positions the department well to harness the power of advanced communications systems to enable field personnel to eventually relay pictures and sketches to other cars in the field; transmit fingerprints; access crime analysis information at a crime scene; and attend roll call remotely while patrolling the beat.

Automated Arrest System Phase II

The Automated Arrest System, launched in 1998, is a client-server application currently used by lockup personnel to enter prisoner intake information during processing. Phase II will shift responsibility for this procedure to arresting officers, allowing them to process the prisoner via soon-to-be-installed computers in interview rooms. Once Phase II is operational, data entered by arresting officers will interface with the department's digital mug shot application (described in a later section) and automated fingerprint identification system (AFIS), allowing lockup keepers to photograph arrestees as soon as they enter the lockup, resulting in real-time records. In addition, watch commanders can upgrade or downgrade charges and approve bookings or subsequent releases online.

Phase II is Web-enabled and will also have electronic arrestee-detainment-tracking capability. At the CPD, increases in the length of an arrestee's detainment require approvals from increasing levels of command, and the application will automatically seek electronic approvals from appropriate command staff as needed. And, various reports will be available on an immediate and per-request basis. Among the reports available will be listings of arrestees on hold at the time of the report generation and arrestees that have been on hold for up to 24 hours, 48 hours or 72 hours. History reports can be generated by a host of parameters, including date

ranges; officers requesting detainments; and number of detainees by detention facility for a given time period, to name a few. Numerous customized reports will be obtainable using available data captured through this new process as well.

Development and Implementation

Eleven formal JAD sessions composed of representatives from 10 internal units and outside agencies were held from July 2002 through the time this report was written, with more to be scheduled. In-depth training will be required for Phase II of the automated arrest application, plans for which had not been announced at the time of this report's writing. Implementation will proceed slowly, probably district by district.

While implementation of Arrest Phase II is scheduled for first quarter 2003, two significant hurdles must be cleared for this to happen. First, the application's funding source must be finalized and, not unrelated, substantial furniture, hardware and wiring will need to be installed in most, if not all, CPD sites with detention facilities. Wiring upgrades probably will be of a smaller magnitude in newer stationhouses; however, furniture and computer equipment will be required throughout the city, as interrogation rooms have historically been quite spartan. Complicating the outfitting of these rooms is the requirement of finding a means to bolt down all furniture and computer hardware for the safety of interrogation room occupants. Pilot testing will likely occur in a recently built stationhouse to take advantage of the reduced need for infrastructure upgrades there.

The Future of the Arrest System Phase II

As mentioned above, implementation is planned for early 2003, and when fully operational, the application will offer increased security within the city's detention facilities because the automatic data flow from arresting officers' input will enable the lockup keeper to focus more fully on the physical aspects of the intake. In addition, it will provide a real-time "snapshot" of lockup occupancy and as well as data to produce management reports and analyses.

Data Warehouse

The data warehouse serves as a queryable data repository that produces a variety of relational reports. Figure 22 shows a screen on which officers might typically begin an arrest-related query. Its data will eventually come from a host of sources, including each CLEAR application, the Records Management System, other agencies sharing information and citizen Web services. Currently the data warehouse holds information on more than 4.5 million arrestees dating back 12 years, with data on an additional 400 arrestees being entered on a daily basis. Each entry contains more than 30 data points, including name, address, age, nicknames and tattoo descriptions. The warehouse also contains information about crime incidents catalogued by crime type, address, time of day, etc. The database currently processes more than 7,000 queries daily. To date, the data warehouse has successfully interfaced with the Records

Management System (RMS), which includes the Office of Professional Standards (OPS); the Internal Affairs Division (IAD), the detective unit; the arrest system; the case reporting system; 311; 911; the mug shot system; the Automated Fingerprint Identification System (AFIS); and the Criminal History Recording Information System (CHRIS). Additionally, sworn members can create real-time “ad hoc” reports as needed.

Figure 22
Data Warehouse Arrest Query Screen

The screenshot shows a web browser window titled "ARREST TABLE FILE REQUEST - Microsoft Internet Explorer". The address bar shows "http://167.165.43.107/Arrests_nc.htm". The main content area features the Chicago Police Department logo on both sides of the title "CHRIS Data Warehouse Name Check Arrest Table Data by Arrestee Address". Below the title, there are login fields for "CHRIS Log On Id" and "Password", with a note: "Enter search criteria in boxes below, then click the [Submit Query](#) button." The search criteria section includes a "Year of Arrest" dropdown menu set to "ALL", "Offender's Residence District and/or Area" and "Beat" dropdown menus, and text instructions: "(Leave Blank To Return Entire City)" and "(Leave Blank To Return All Beats)". There are input fields for "IR NUMBER" and "CB NUMBER". A note states: "* Additional Search Options, data that coincides with the information known, i.e. sex/race/dob, or by a partial name, etc." Below this are fields for "LAST NAME", "FIRST NAME", and "NICKNAME". At the bottom, there are fields for "ARRESTEE STREET NUMBER" and "STREET", with a "DIRECTION" dropdown menu. Instructions "(Whole, Partial or Leave Blank)" are provided for the street fields. The Windows taskbar at the bottom shows the Start button, several application icons, and the system tray with the time "2:06 PM".

Development and Implementation

The users of this system range from special units to the Patrol Division, and while the data warehouse is a work in progress, many officers have demonstrated their interest by using the available pre-packaged reports, as well as by making special requests for unique reports. Because the user base is so broad, training is needed to reach all levels at the CPD. Training is ongoing and is being conducted in various ways. Some training was conducted at the academy,

while other training efforts involved officers going out to area headquarters and training large groups of people. In addition, there is a volunteer cadre of “information providers” in the districts and area headquarters. The volunteers undergo a two-day training, and their role is to run reports or help people when they know what they need but do not know how to get it. To date, the biggest users of the data warehouse have been Data Systems Administration, the detective unit, Youth Division, the Office of Management Accountability, and the Bomb and Arson section. District-level use is fairly even. The department has experienced very little resistance to this application because users, in general, rapidly see the speed and richness of the data available to them. Real-time arrest data from 132 suburban Chicago jurisdictions are also entered daily, and sworn members of these agencies also query the system.

There is continued work to integrate a variety of information from “legacy” systems; these are mainframe and minicomputer systems that pre-date local area networks (LAN) and wide area networks (WAN) internetworking. Additionally, there is constant entry of arrest and case reports that date back further than 1999. The manager of this application does not have a “hard and fast” deadline to meet in terms of completion of the application, but believes, in general, things are moving along at a good pace in terms of getting more data into the warehouse.

The department would like to make the data warehouse information available to officers in cars through the Automated Information Recording System (AIRA), but bandwidth appears to be the obstacle that currently prevents this from working.

The Future of the Data Warehouse Application

The overall goal is to incorporate more and more systems into the data warehouse. In particular, the department would like to incorporate Crime Mapping and Analysis (ICAM), Citizen ICAM (which is available to the public via the Internet), additional pre-packaged reports and information from other agencies willing to share their information – particularly other law enforcement agencies. To date, there has been no discussion of involving agencies outside the law enforcement arena, nor of the general public being able to input or tap into the data warehouse in any capacity. Citizen ICAM allows the public to map crime information by area, but citizens do not have an avenue for providing data or information to the department.

Digital Mug Shot

As recently as 1994, the CPD relied on Polaroid cameras to capture mug shot photographs of offenders. In 1995 the CPD updated its mug shot system with digital cameras at a cost of \$3 million. The system required large steel stands to house the cameras, jumbo flashes, storage boxes for each camera-dedicated PC and elaborate data storage techniques. The system provided quality photos but only captured minimal data for reporting. The 1995 system also required mug shots from individual districts to be captured on an area server that handled four other districts’ mug shots, eventually routing them all to a central server at CPD headquarters. The system’s intended life span was approximately four years, and by late 2000 it had become

very unstable, resulting in frequent crashes and time-consuming searches. Other problems generated by the system included omitted mug shots, Central Booking (CB) numbers not matching the correct suspect's mug shot and lockup keepers making too many processing mistakes. According to a CPD insider, the 1995 system was "barely getting by – limping along." In 2001 it was determined that the 1995 system had outlived its usefulness and was beyond repair, requiring the CPD to begin the process of looking for a new mug shot system.

The department's new Digital Mug Shot System enables detectives to create virtual line-ups, provides an avenue for the Internal Affairs Division (IAD) to track officers' work, creates an interface to keep the sex offenders list accurate and up-to-date and, lastly, upgrades mug shot data capture techniques in the department's lockups. A digital mug shot is shown in Figure 23.

Figure 23
Digital Mug Shot



CB	Arrest Date	First Name	Middle Name	Last Name	Hair color	Eye color	Race	Weight	Height	Sex	DOB
15317204	10-Dec-2002	Voice	O	Reason	Bro	Bro	Whi	230	6'02"	M	01-Dec-1960



Development and Implementation

The development of a new digital mug shot application began to take shape in January 2001. After much deliberation, a local company was selected by the CPD in March 2001 to develop the new mug shot system. While this company's bid was somewhat higher than that of other vendors, the department decided to contract with this company because it met all of the CPD's hardware, software and technical support requirements. Initial project management by both the CPD and the vendor was not very strong and, as a result, the project progressed slowly for the first six months. A change in management resulted in new life and direction for the digital mug shot application. The vendor conducted interviews to determine the CPD's needs and to identify units within the CPD that would benefit from access to the new Digital Mug Shot System. In addition, a civilian chief database analyst from the Data Systems Division was appointed by the executive administrator of Information and Strategic Services to head the CPD's development of the new digital mug shot application. The new mug shot manager assembled a four-person support team of Data Systems personnel and joined the vendor in finalizing the development plan and testing new hardware.

The department's two main hardware needs for the new digital mug shot application were digital cameras and new computer servers. The vendor's first camera recommendation was rejected by the CPD, so a search began anew for a digital camera that would meet the CPD's specifications: high mega-pixel count for clear, crisp pictures; zoom features; and automatic picture downloads to the CPD's data warehouse. By April 2002, the vendor identified a Canon camera that had the required specifications. However, after three months of testing in a pilot district, the CPD realized that the camera had some drawbacks – it required the lockup keeper to look through the viewfinder, snap the picture and then check picture quality via the attached computer. The CPD wanted a camera that provided a live pre-shot image on the computer screen so all picture-taking steps could be completed from the computer stand. By July 2002, the vendor was close to endorsing a \$2,000 camera that would provide a live image and be controlled from the computer workstation. Around the same time, CPD management changes slowed development.

Testing of the new live-image camera began in the pilot district in early August 2002. However, at the time this report was written, no decision had been made about whether the camera would be selected. Some of the images from the new camera had a greenish hue, perhaps because the camera lacks a flash and the pilot district's lockup is poorly lighted. The greenish hue is a matter of concern because mug shots must accurately portray color, especially when it comes to distinguishing marks such as tattoos and scars. And, many of the lockups in the city are somewhat dark.

The other hardware requirement – a server system capable of handling a large volume of pictures – was met by the department's purchase of several servers to accommodate CLEAR. The new Digital Mug Shot System requires the use of a storage area network (SAN) to store the mug shot pictures and two servers to run the digital mug shot application. One of the servers is used as a stand-alone backup in case the main mug shot server fails. It is expected that in the

event of a main server failure, the backup server would take over in a matter of minutes. Mug shot files can now be quickly searched. New servers also eliminate the need for area servers and allow each lockup to send mug shots directly to CPD headquarters. According to the vendor, the two servers are working well and are providing ongoing system updates.

The new Digital Mug Shot System is designed with different functionality for a variety of end users; however, the focus of the system is the processing of offenders in the department's lockups. The process goes as follows: An arrestee is brought into the lockup and processed via the Automated Fingerprint Identification System (AFIS), which sends arrest information to the computer linked to the mug shot camera. Before being put into a holding cell, a CB number is written in ink on the prisoner's arm. When the lockup keeper is ready to remove the prisoner from the holding cell to take the mug shot, the lockup keeper checks the computer for the correct CB number and gets demographic information on the arrestee. The demographic information gives lockup keepers a much better idea of who to look for when removing a prisoner for a mug shot. This is an important improvement over the old system, which did not show demographic information. In the past, this lack of information sometimes resulted in a mug shot being associated with the wrong CB number. When the lockup keeper confirms that the correct arrestee has been selected, mug shots are taken – sometimes as many as six photos per prisoner, including closeups of tattoos and scars. Mug shots are then sent to the SAN, printed out and attached to the prisoner's file.

The print copy is an important upgrade requested by lockup keepers. The photo is now checked before prisoners are released, ensuring that the correct prisoner is being released. Another change is that the new mug shot system requires lockup keepers to take mug shots in the order that prisoners are processed in AFIS, again to increase the likelihood that the mug shot will be taken and processed correctly. The only way around this is with an override from the desk sergeant or district commander, though all sergeants have been given bypass authority so lockup keepers are not delayed if a desk sergeant or commander is not available. According to the vendor, these steps in the new mug shot application should eliminate 90 percent of human errors associated with lockup procedures.

While lockup personnel are the primary users of the new Digital Mug Shot System, the system also has separate functionality for various authorized users including: the Detective Division, IAD, the Identification and Graphic Arts Sections, Administration and the Sex Offender Registration Unit.

Detective Division. After logging on to the mug shot system, detectives are presented with a main menu that includes query, line-up and help functions. The help function is currently inoperable but will eventually offer a searchable help manual. The query function allows detectives to search for offenders by CB and identification record (IR) numbers, sex offender registration and social security number. It also can query by demographics, personal features (hair color, height, weight) or date of offense occurrence. For example, detectives can enter a CB number, and the new Digital Mug Shot System will find the offender and list his or her name, CB number, criminal history, demographics and mug shot image. An option only available to

detectives is the “create a line-up” feature. By checking “add to line-up,” the offender’s mug shot is added to a virtual line-up. Detectives can then have the system query similar-looking offenders to fill out the rest of the line-up. The system will find mug shots of hundreds of offenders in the CPD database who closely match the offender’s gender, race, hair color, height and weight.

The system handles up to nine photos in a line-up. When detectives are satisfied with the line-up, they can display it entirely on one page or in a cascaded fashion (one picture per page). Once saved, the line-up is date- and time-stamped, which serves as a reference. If the line-up remains unchanged, it will forever be saved with the time stamp. The line-up can be recalled and changed, but any saved changes generate a new time stamp.

Internal Affairs Division. IAD uses the mug shot system to monitor the activities of CPD personnel. All CPD employees’ ID photos are stored in the mug shot system, and they are linked to their personnel data information. IAD’s menu choices are similar to those of the detectives (query, line-up, help), but IAD personnel can use the system to ascertain how an officer went about creating a line-up; to determine whether the system is being used appropriately; and to investigate any charges of officers selling photos of undercover officers to street criminals.

Identification and Graphic Arts Sections. Authorized employees of the Identification Section (IDENT) have the ability to query different photos as well as modify and delete them. If, for example, a lockup keeper takes a mug shot of a prisoner with an incorrect CB number, a call must be placed to an authorized IDENT employee to fix the error in CHRIS by deleting the entire record, thus allowing the lockup keeper to start over. Errors in information that has already been keyed into CHRIS, like the wrong mug shot being linked to a CB number, are also fixed by IDENT personnel. Graphic Arts is responsible for all field mug shots; usually this means going to hospitals, taking mug shots of wounded prisoners and scanning those pictures into the mug shot database.

Administration. The administration functionality of the mug shot application gives trainers, the Help Desk personnel and CPD administrators access to the mug shot system for all administrative requirements, such as changing a user’s login identification or fixing a technical problem.

Sex Offender Registration Unit. Convicted sex offenders in the City of Chicago are required by law to register their address with the CPD. The department, in turn, is required by law to keep mug shots and addresses up-to-date and available for the public. The new digital mug shot application provides the interface for the CPD to maintain the sex offender registry and provide public access.

Training and Implementation

For the digital mug shot application, the vendor's representative conducted the first classes, and the Data Systems sergeant in charge of CLEAR application training provided input. Classes were held in the Data Systems computer lab at headquarters, and the Data Systems training team sat in. Participants were instructed via two large monitor screens that mirrored the training screens used by participants. The classes began with a very brief history of mug shots in the CPD and an explanation of the current status of the application. After several sessions, the training team gained a sufficient level of knowledge about the system and assumed all further training responsibilities.

Training for all of the main user groups, except lockup keepers, was conducted between February and May 2002. Instruction focused on the groups' specific use of the new Digital Mug Shot System, and the various options for each were examined and tested. Participants were informed that the Help Desk would be available for technical questions. Sessions were not lengthy, and entire user groups were trained over the course of a few days. As each group completed its training, screens pertaining to their functions became accessible.

Training and implementation for the remaining group – the lockup keepers – was originally scheduled for November 2001. However, when the new servers arrived, it was learned that electrical upgrades were needed in some of the stations. The rewiring process took longer than expected due to holiday schedules. After this and other setbacks, pilot testing of the new mug shot system began in mid-March 2002. However, until a final decision is made about a camera, no firm date for training and implementation for the lockup keepers' portion of the Digital Mug Shot System will be set.

Training for lockup keepers will be held onsite over all three watches, with perhaps as little as 15 minutes of instruction needed per lockup keeper. Trainers will return on the ensuing two or three days to work out any bugs and answer additional questions. When training is fully delivered at one site and the live version of the new Digital Mug Shot System is functioning, the trainers will move on to the next lockup site.

Impact. Some resistance is expected with this and all CLEAR applications. However, all user divisions were consulted prior to development, and the general consensus seems to be that the benefits of the new system greatly outweigh any negatives. Lockup keepers will be affected most by the new system, and their biggest complaint thus far concerns their lack of bypass authority. According to one CPD insider, this restriction is in place “to not let them screw up” and to compel them to follow correct procedures when processing offenders.

The Future of the Digital Mug Shot Application

The digital mug shot application is designed to interface with outside agencies' systems. Cook County is putting its photos into the CPD's data warehouse via the CPD's new Digital Mug Shot System. Data will be shared with the Illinois State Police auto theft division and the

National Insurance Bureau. And, as mentioned previously, the Digital Mug Shot System will continue to provide access to the sex offender Web page that displays pictures and provides information to the public about sex offenders in the Chicago area.

There are anticipated obstacles and concerns with the new Digital Mug Shot System. Finding an acceptable camera or camera setup still remains the most pressing problem. Despite many upgrades in the new system, there are still concerns that lockup processing delays, photo inaccuracies and questionable judgment of lockup keepers when recording arrestee demographic information could lead to the loss of important information. Another area of concern is the handling of youth mug shots. Currently there are no mug shot cameras in the youth lockups, so juvenile arrestees must be transported to the adult lockup, processed in a separate area outside of the adult lockup and then have their mug shot taken in the adult lockup.

Maintenance of the new mug shot system is included in the vendor's contract with the CPD, as are parts and labor. However, one CPD informant expressed concern that changes made to the system might be costly if the vendor charges excessive fees for those changes.

Another mug shot application issue that still needs to be worked out is the user authorization policy. As with all CLEAR applications, levels of access to the Digital Mug Shot System is limited by officer status. However, all officers have the equivalent of lockup keeper status within CHRIS; thus, all officers would have access to the lockup portion of the new mug shot system. One solution is restricting access to the lockup portion of the system to lockup keepers and their supervisors. However, this arrangement prevents patrol officers from filling in when lockup keepers are out for the day (sick leave, day off or furlough). Faced with this predicament, some within the CPD feel all officers should be given access to lockup keeper functions. A final decision will need to be made.

Finally, the issue of deleting or backing up information has not been resolved. All information in the new Digital Mug Shot System – including deleted information – is currently backed up on tapes. This gives the vendor the ability to bring back any mistakenly deleted information should such a situation arise. However, this presents problems with court orders to delete a person's file and mug shot. The information would never fully be deleted in the new mug shot system because of the data-recovery ability. The vendor could stop providing data back up to satisfy the courts, but such action would provide the CPD very little room for error. A final decision will need to be made on this matter as well.

eTrack

The Chicago Police Department is automating evidence and recovered property inventory and tracking, one of its core functions, with the multi-phased deployment of eTrack. The first phase, launched in summer 2002, provides electronic data capture. Automated tracking of evidence and property will be upgraded with the implementation of eTrack's second phase, which will replace the Criminal Evidence Recovered Tracking System, the department's legacy

application known as CERTS. eTrack's third phase will incorporate upgrades that enhance functionality.

Thus far, eTrack enables officers and evidence technicians to record new inventories and specify their destination. The application is available via any computer with access to the CPD intranet. After logging on, officers input the same information on evidence or property that was captured on the previously used five-part handwritten form. Figure 24 presents the electronically produced inventory record. Supervisors approve the inventory electronically after the officer submits it electronically, and a bar-coded label is printed and attached to the package. eTrack also enables electronic manifesting, with couriers scanning the bar-coded label of each package to be transported. In addition to creating a manifest document, this process provides a cross-check that ensures that all evidence or property approved for transport is picked up. When the evidence or property arrives at the Forensics Services Section (crime lab) or the Evidence and Recovered Property Section, the receiving officer rescans the package to acknowledge its arrival. Thus, with the completion of phase one, all handwriting has been eliminated from the inventorying process. In addition, inventories can be queried by any number of variables.

Figure 24
Inventory Record Printout

PROPERTY INVENTORY - NO.		10012338		LIST OTHER INVENTORY NOS. RELATED TO THIS RECOVERY		UNIT	INVENTORY NO.	
CHICAGO POLICE DEPARTMENT CPD-34.623 (REV. 1/99)						019	10012338	
DATE RECOVERED 30-MAY-2001		CROSS REFERENCE		RD		G312085		
LINE	QUANTITY	DESCRIPTION OF PROPERTY						
1	1	PRINTE TENNIS RACQUET						
2								
3								
4								
5								
6								
7								
COMMENTS: previously inventoried under 2524811		\$ TOTAL CASH U.S.C.						
EVIDENCE/RECOVERED PROPERTY SECTION USE ONLY		OFFICER'S SIGNATURE - STAR - UNIT						
Court Date		WATCH COMMANDER'S APPROVAL SIGNATURE (EXCEPT RANK REQUIRED FOR FIRARMS)						
Court Branch		COURT ORDER - DISPOSAL INSTRUCTIONS						
Court Call								
CHECK ALL BOXES APPLICABLE		COURT ORDER - DISPOSAL INSTRUCTIONS						
<input type="checkbox"/> U.S. CURRENCY TO BE DEPOSITED		<input type="checkbox"/> U.S. CURRENCY TO BE HELD IN ORIGINAL FORM - DO NOT DEPOSIT - (MUST SUBMIT TO ROOM)		<input type="checkbox"/> C.P.D. CONTINGENCY FUND MONEY		<input type="checkbox"/> GAMBLING RAID SEIZURE		<input type="checkbox"/> MEDICAL EXAMINER'S PROPERTY
<input checked="" type="checkbox"/> MISDEMEANOR STATE CHARGES 720 ILCS 5.0/116A-3-A		<input type="checkbox"/> FELONY		<input type="checkbox"/> JUVENILE		<input type="checkbox"/> HOMICIDE		<input type="checkbox"/> ARSON
<input type="checkbox"/> DECEASED		<input type="checkbox"/> ARRESTED		AT 2801 N. LAKEVIEW AVE CHICAGO, IL		BEAT OF RECOVERY 1982		
OWNER'S NAME GALVANONI, CARLA		ADDRESS 2801 N. LAKEVIEW CHICAGO, IL		TELEPHONE NO. 77893592		JUDGE		CT.BR.
FOUND BY - NAME		ADDRESS		TELEPHONE NO.		OFFICER'S SIGNATURE - STAR - UNIT		X
<input type="checkbox"/> CHECK IF C.P.D.		INVESTIGATING OFFICER - DABE, JOHN		STAR NO. 19810		UNIT 019		1st OFFICER'S NAME DIAZ, DAVID
<input checked="" type="checkbox"/> HOLD FOR INVESTIGATION AND/OR EVIDENCE (IF NOT NEEDED FOR INVESTIGATION/EVIDENCE, LEAVE BLANK)		HOW NOTIFIED		SIGNATURE		UNIT		E & R.P.S. USE ONLY
<input type="checkbox"/> PROPERTY OWNER NOTIFIED ON TO PICK UP PROPERTY WITHIN 30 DAYS OR PROPERTY WILL BE DISPOSED OF		<input type="checkbox"/> IN PERSON		Electronic Approval		019		
<input type="checkbox"/> TO BE DISPOSED OF BY CUSTOMER (NOT TO BE RETURNED) (THIS APPLIES IF PROPERTY IS NOT EVIDENCE, NOT RETURNABLE AND/OR OWNER IS UNKNOWN)		<input type="checkbox"/> PHONE		<input type="checkbox"/> MAIL		2nd OFFICER'S NAME DABE, JOHN		STAR NO. 19810
INITIAL DESTINATION OF PROPERTY		<input checked="" type="checkbox"/> E & RPS		<input type="checkbox"/> CRIME LABORATORY		<input type="checkbox"/> MEDICAL EXAMINER		<input type="checkbox"/> AUTO POUND NO.
VIA		<input type="checkbox"/> POLICE MAIL		<input type="checkbox"/> RECOVERING UNIT PERSONNEL		APPROVING DESK SERGEANT		STAR NO.
<input checked="" type="checkbox"/> E & RPS PICKUP		<input type="checkbox"/> EVID./LAB TECHNICIAN				DATE		TIME

Though to date only phase one of eTrack has been launched, its impact on the CPD has been substantial on many dimensions. From a sheer breadth standpoint, eTrack impacts every individual who might need to inventory evidence – essentially every sworn member of the department. In addition, electronic inventorying offers improvements in officer time-management, legibility and integrity of data, accuracy of disposition and courier accountability.

As officers become familiar with eTrack they are able to save time by keying in inventories in less time than it took to fill out the old written form. Additionally, prior to the launch of eTrack, each “intake unit” had only one inventory collection book. Therefore, officers needing to record a piece of evidence or recovered property often would spend a considerable amount of time in the station either tracking down the inventory book or waiting until other officers completed their work and supervisors approved it. In addition, correcting and inventorying electronically is likewise more efficient. Rather than having to white out changes on a five-part written form, officers need only log on to an edit page, and the correction is quickly and neatly accomplished. What all of this means is that officers should be able to return to their street assignments more quickly than in the past.

Legibility issues no longer exist, because nothing is handwritten. Before eTrack, a copy of the inventory form was sent to data entry clerks who were responsible for deciphering officers’ handwriting and keying data into CERTS. This step was eliminated with Oracle’s development of an interface that “migrates” data collected via eTrack to the CERTS database. The level of accuracy is automatically enhanced because of features that include all data fields needing to be filled before the report can be submitted to a supervisor; incident numbers being validated against 911 calls; addresses corresponding to the city’s geocode file; and other such features.

The disposition of evidence and recovered property is accurately recorded and traceable with eTrack, because all inventories require that an “action” field be filled. Officers must specify what will be done with the property and how it will be transported to the appropriate destination (crime lab, Evidence and Recovered Property Section, etc.). The location of the property or evidence can be determined at any time by querying the system.

eTrack also provides accountability for the couriers, because pickups are time-stamped. Supervisors can, if necessary, ascertain whether couriers are managing their time appropriately.

Development and Implementation

The eTrack project began in July 2001, and an Oracle project manager was assigned to co-develop the evidence tracking application within weeks of that. Weekly JAD sessions were held for stakeholders over a four-month period, and Oracle submitted a scope, objectives and approach document by early December of that year.

After the document was accepted, development of the application began and was essentially completed by mid-February 2002. During this period, the CPD project manager

conducted site surveys to determine hardware resources and accessibility in district stations and other facilities where evidence and recovered property are inventoried. This survey revealed that additional workstations were needed and that various facilities adaptations would likely make implementation more successful. Also during that time, vendors were located and contracts finalized for supplying bar code scanners and printers for each site. Because this process went so smoothly, hardware installation and implementation of this aspect of eTrack, originally planned to be part of phase two, was realized in late September 2002.

Pilot testing of eTrack phase one was carried out by the CLEAR training team to not only ensure that the application worked as expected, but also to sufficiently familiarize them with eTrack to carry out the large-scale training operation before them. Because every sworn member at each evidence intake facility would need to be trained, the decision was made to have trainers onsite, around the clock at first, in each facility as eTrack was introduced. So, when eTrack was launched at the pilot site in early June, members of the development team and trainers were at the station from midnight on to address roll calls and give demonstrations, and subsequently provide individualized hands-on training for all sworn personnel. After it was determined that everything was working smoothly, the development team turned everything over to the trainers, who stayed at the pilot station for two weeks. Once eTrack “went live” at the pilot station, it became the only method for inventorying evidence or property at that site. The development team returned to the pilot test station several nights later to observe how the application functioned under high volume circumstances – during a mission resulting in many arrests. After an essentially problem-free launch at the pilot site, an aggressive implementation scheduled was followed, with trainers staying at each site for two days. By early September 2002, eTrack became the standard means for inventorying evidence and recovered property in the Chicago Police Department.

Training. Onsite training began with a member of the training team addressing roll call and giving a presentation of how to inventory a piece of evidence, eliciting suggestions from participants on hypothetical information with which to fill the data fields. Officers were encouraged to ask questions throughout the demonstration, which was visible on large monitors in the roll call room. At the conclusion of roll call demonstrations, officers were called in by car to sit with a trainer for one-on-one training. “Test cases” were used for training unless officers happened to bring in evidence after an arrest. In such cases, officers received training as they inventoried the evidence on eTrack. Test-case training took place on a portion of the intranet known as the “sand box” – a place where officers are encouraged to “play around” with the new application. Those receiving individualized training signed in to ensure that officers not on furlough were trained before the team left the facility and to acknowledge that they had received a 25-page user’s guide. More than 7,500 officers were trained on eTrack by CLEAR training personnel. Those not trained by the team were instructed later by district officers designated as trainers. The CPD Help Desk also received training from the CLEAR training team and was available for questions from the time eTrack went live at the pilot site.

Training team members were also onsite as the new eTrack hardware (bar code printers and scanners) was introduced at the various evidence intake facilities throughout the city.

Printers were installed by the vendor and scanner installation was handled by the training team. Training at evidence intake sites was virtually unnecessary because the only new change associated with this upgrade was for sergeants – one screen had been removed and a new box appeared on an existing screen that denoted their approval for a courier’s removal of evidence or property from the site. However, approximately 20 couriers based at CPD headquarters as well as 100 evidence and recovered property receivers based at one facility would need simple instruction on use of the bar code scanners. This was accomplished in a two-week period prior to implementation.

Implementation and Impact

Phase one of eTrack was implemented with no significant obstacles on the “front end data capture” side and has been well-received by users. However, users represent only one part of the equation. Receivers of data captured by eTrack – the Forensics Services Section and Evidence and Recovered Property Section – represent the other. Interviews with receivers produced somewhat mixed reviews.

On the whole, there is enthusiasm for the application. However, there are occasional problems with the interface between eTrack and CERTS. Once in a while, automatic data transmission from eTrack to CERTS is not smooth, resulting in a situation in which evidence arrives at its destination, but the corresponding eTrack information is not accessible. A printed list is generated for all such transmission difficulties, and there is no loss of data. The degree to which this is troublesome seems to relate to informants’ level of technical expertise: those with a more sophisticated computer background viewed interface problems as something requiring extra troubleshooting, but nothing that diminished the application’s value. Others with more basic knowledge indicated that considerable effort goes into the resolution, opining that creating the eTrack system in phases was ill-advised. However, the application’s harshest critic admitted that eTrack phase one solved several problems even though it created a few new ones.

The eTrack project managers acknowledged the interface problems, explaining that the difficulties were anticipated because CERTS is such an old system. Despite this, the decision was made to launch eTrack in phases for a few reasons. First, knowing that the rank and file – eTrack’s users – is always a difficult group to sell on a new application, the managers decided to get the “front end” developed and launched as quickly as possible. The benefit of doing so, in their estimation, outweighed the problem of occasional difficulties with the interface. They also firmly believed that they could establish credibility by rolling out the first phase rather than taking extra time to develop the entire module, which would contribute to the officers thinking that the application would never become a reality.

The Future of eTrack

As mentioned earlier, eTrack phase two is currently scheduled to be completed by the end of 2002. JAD sessions are ongoing. As the target date draws nearer, if it appears as though it is too ambitious, the date will be pushed back, or the scope of the project may be reduced. This

could postpone the launch of some features until the third phase (functionality enhancements) is launched in spring 2003.

In addition to replacing the CERTS system, phase two will provide a data feed to the Illinois State Police Forensics Lab, where all evidence is eventually sent. When CHRIS is incorporated into CLEAR, data from eTrack will reside within the CLEAR database, and all evidence-related data will be queriable through the data warehouse.

Gang Module

By the mid-1990s it was internally apparent that the department's system for collecting and analyzing gang information was disorganized and ineffective. The system was a paper-driven process that isolated operational units and made interdepartmental sharing of critical gang information very difficult. Recognizing the need for a central database that would allow identification and tracking of Chicago area gangs, in 1998 the CPD began development of a Gang module that would interface with CHRIS. The goal of the Gang application, to be developed in several distinct stages, is to enhance the department's ability to record gang information, reduce system redundancies and create a database that will enable officers to engage in predictive analysis.

Development and Implementation

At the beginning of the project, the commanding officer of the Research and Development Unit became project manager of the Gang application. Five principle areas of the Gang database were developed in stage one, which was completed in approximately two years:

- Member profiles – a fully automated gang arrest database that functions as the department's first step in identifying an arrestee's gang affiliation. This was 90 percent complete at the end of stage one.
- Organization profiles – an online source of gang profiles including descriptors such as gang type; history; factions; rivals; symbols and signs; and documents and photos. At the end of the first stage, about 50 percent of this area was completed.
- Gang incident review – enables citywide or beat-specific analysis of criminal gang activity. This section is linked to member and organization profiles as well as to the department's crime-mapping system for identifying and mapping criminal gang activity. Gang incident review was 35 percent completed at the end of stage one.
- Administrative reports – generates detailed gang-activity reports for field and command personnel. Approximately one-third was completed at the end of stage one.
- Major case operation file – provides narcotics investigators and gang specialists with the ability to conduct comprehensive long-term investigations more efficiently by providing

all available information that may be associated with the case. Work on this area has not yet begun.

A work plan for the second stage Gang application development has been drafted, and a grant proposal to fund it was submitted in September 1999. Stage two work has four main goals:

- Completing gang incident review – considered the focus of stage two work, the system will be customized to identify, track and analyze narcotics gangs, as well as to link narcotics tip information with the criminal gang database. In addition it will automate the processing of new arrest data and the interpretation of arrest and case data.
- Enhancing compliance and data security – ensuring the Gang module's compliance with regulations guiding federally funded multiagency criminal intelligence systems. This entails establishing and maintaining acceptable standards for submission and entry of criminal intelligence information, its dissemination to other agencies, and the review and purge process.
- Enhancing the Police Patrol Task Force program – development of a program that will provide for accurate sharing of gang parolee information between the CPD and the Illinois Department of Corrections, aimed at identifying high-risk parolees who may return to ongoing criminal activity.
- Developing the major case/operation file – begin creating case objectives, confidential links to targeted gang members and surveillance investigative notes.

The grant proposal for stage two development of the Gang module received preliminary approval. However, questions about the module's compliance with federal regulations delayed disbursement of funds. Nearly two years later, the CPD received federal notification that the Gang module would not violate privacy statutes. Unfortunately, the grant specified that funding was to be used by September 30, 2002, which proved to be an impossible timetable because of the CPD's involvement in developing CLEAR applications. Thus, the department opted to delay stage two development until the following year and seek new funding.

The Future of the Gang Module

According to a CPD informant, stage one work of the gang application created a reliable system that tracks gang membership, and stage two, when completed, will enhance the system and prompt officers to ask questions they might not have contemplated. The expectation is that as the Gang application expands, the ever-growing database will provide easily accessed, rich information that can be used to anticipate emerging gang activity.

There is much enthusiasm about the nascent Gang application, and the gang application project manager was looking toward development of a third stage focusing on comprehensive sharing of information as well as toward a fourth aimed at community gang prevention.

Functions that may be added in the future include a predictive analysis tool as well as computer-generated notifications to officers of specific information related to gang cases on which they are working.

However, at this time, future development of the Gang module is uncertain, because the project manager was reassigned and has yet to be replaced. In addition, until new funding is secured, development will remain on hold.

Crime Mapping

Background

To date, the effect of citizens giving and receiving public-safety-related information on their perceptions and behaviors remains poorly studied (for early research, see Lavrakas, Rosenbaum & Kaminiski, 1983). Yet information technology, particularly access to the Internet through personal home computers, opens a welcoming door for citizens to become actively engaged with local police in new and creative ways. In cities such as Sacramento and San Jose, California, police are beginning to experiment with allowing citizens to report crime and disorder incidents via personal computer. Almost a decade ago Chicago began to share information with its citizens through crime maps produced by its Information Collection for Automated Mapping (ICAM) system. Today, everyone can access an easy-to-use Internet version of ICAM to draw their own crime maps. One police chief recently summarized the situation: “The bottom line for police departments committed to community policing is this. Absent a compelling reason not to (and there are legitimate reasons), information that police departments provide to our members should also be provided to our residents, and it should be provided with similar speed and detail. Only then can we expect our partners in community policing to have the information they need to be fully equipped and engaged.” (Ramsey, 2002, p. 42)

ICAM was launched in 1994, and the public version, known as Citizen ICAM, became available in 2000. Figure 25 presents a crime report generated by Citizen ICAM. This mapping application relies on a Geographic Information System (GIS) to graphically represent data in the form of a map, enabling officers to perform crime mapping and analysis, while Citizen ICAM gives the public access to the CPD’s database of reported crime. Both versions allow users to view crime activity in map, chart or table form and to search crime activity by beat, intersection, specific address or type of crime. Information pertaining to victims or potential suspects and exact addresses of incidents does not appear on Citizen ICAM. Such information is accessible, however, on the department's version, which is a secure mapping program.

Figure 25
Citizen ICAM Report

CITIZEN ICAM CRIME REPORT MAP

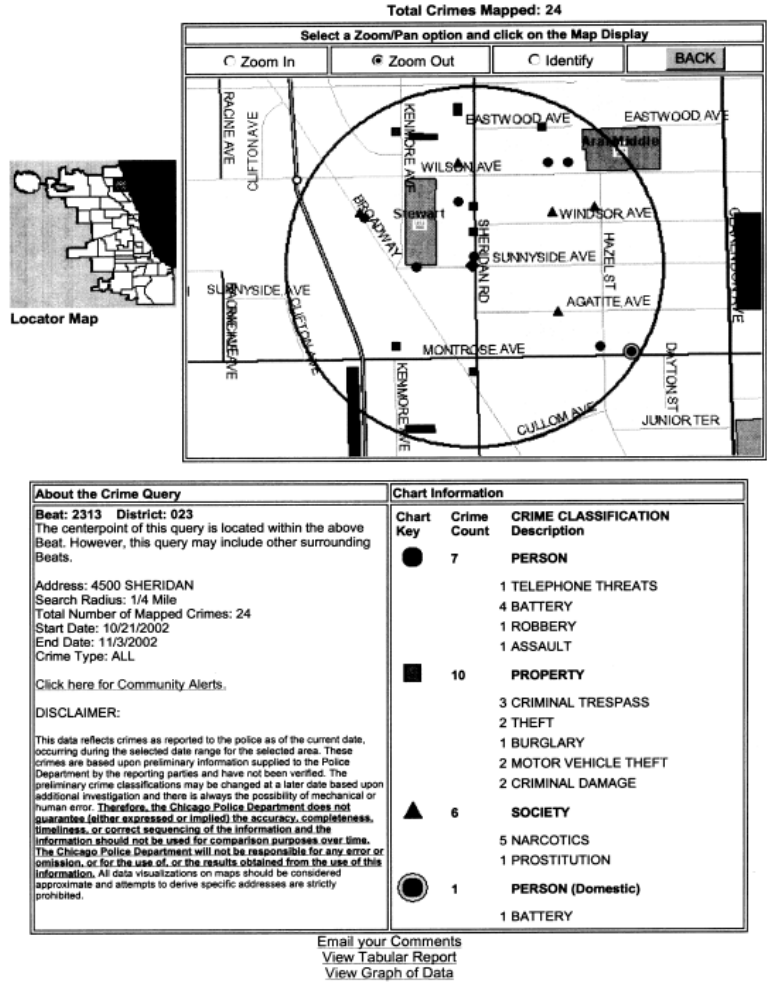

Current ICAM reports provide many invalid addresses – 20 percent or more, according to a CPD informant. These inaccuracies exist because historically, officers filling out case reports have had difficulty identifying actual addresses at incident locations (vacant lots, for example) and have resorted to guessing. The cumulative effect of their guessing has resulted in a system with many faulty incident locations.

To provide more accurate mapping, the CPD is retiring ICAM and centralizing its computer mapping capabilities at headquarters by means of a new system that will allow officers to search for correct addresses before they enter incident locations into a case report. Officers will be able to input the approximate area of an incident, and the new mapping application will

use corrected GIS information to identify the exact address/location for a case report. Eventually, this will be available wirelessly on the portable data terminals installed in police cars.

In September 2001 the department hired a civilian with 18 years of GIS experience to manage development of its new mapping system. The manager hired a senior programmer in mid-2002, and together they have been able to move forward with development, although slowly. An analyst is expected to join the team in early 2003.

Developing the system involves three distinct activities. The first consists of updating and correcting the geographical data. ICAM's operating system does not allow modifications to be made to its base information, so an automated extraction program is performing the laborious process of removing inaccurate data from the existing ICAM application, correcting it and translating it into the new mapping application. Because of the accurate historical data's value in tracking crime patterns and trends, the process must be carefully monitored to ensure that data are not overwritten or lost.

The second important development activity entailed locating a geocoding application that validates geographical information as it is entered to ensure that officers in the field could only enter accurate addresses. An outside vendor developed such an application for the CPD, and it is currently working successfully in pilot testing with AIRA, the department's new automated incident reporting system. When AIRA is operational, a "Map It" option will display on the PDTs, enabling officers to check address validity.

Adding enhancements and functionality to the new mapping application is the third development activity. The new system will draw data from additional sources of information, such as the 911 Center, the Department of Revenue and the Department of Buildings; track domestic violence incidents; and have expanded search and analysis capabilities. In addition, the system will enable officers to use GIS information in investigations. For example, if there is a rash of stolen vehicles in an area, officers will be able to query the data warehouse to determine whether conditions such as road work led to an increase in poorly lit side street parking that, in turn, possibly contributed to an increase in stolen vehicles. Another planned function within the new mapping system will allow officers to check for building specifications – number of rooms and floor plans – of premises they need to enter. One goal of the enhanced mapping application is to enable users to access data on buildings throughout the city – a goal that will be realized only if businesses and other organizations make their data available to the CPD. Finally, the new mapping system will employ aerial photography technology to provide zoomable satellite photos of buildings and structures. When a contract has been settled between the City's Law Department and the vendor, the aerial photos will be stored in and displayed by the new mapping system.

Plans for pilot testing are not finalized, but testing is expected to happen in a technology-savvy district over the course of a month. The intention would be for the pilot district to extensively test the new mapping application and provide feedback to guide final edits and fixes.

After a successful pilot test, a basic mapping system would become available, with additional features and business/building information added over time.

Training. Training is not an immediate concern, but the academy will be the likely site for hands-on retraining of current officers, while new officers will learn to use the application as part of their curriculum.

Implementation and Impact

Development was originally scheduled to start in late summer 2002, with rollout at the end of the year. However, numerous setbacks, including hiring restrictions and ad hoc projects assigned to the development team, have significantly pushed those dates back. The current target date for the deployment of the new mapping system is March 2003.

All sworn members of the CPD will have access to the new mapping system, though Patrol Division officers will likely use it most frequently. Significant resistance to the new application is not expected. The system will be accessible via CHRIS, which can be a “painfully slow or very fast” process depending on the district stationhouse (old or new) from which the application is accessed. The GIS manager believes that “network speed is critical” for the success of the new system; slow retrieval times will definitely discourage users.

The Future of Crime Mapping

At the time this report was written, the mapping application had issues still needing resolution. Outside consultants are needed to help create an interface between the newest technology and the CPD’s current technology. New hardware is also needed: the enhanced mapping system’s database will require additional disk space to store data and color images, necessitating a second server to ensure that search time will not be protracted as data and photo collections grow.

The department will no longer need to maintain a citizen version of the new mapping application, because the new system will permit community access to certain levels of information. The new setup will require significant security measures to prevent improper access. These measures have not yet been determined.

Juvenile Arrest

Until recently, the CPD’s juvenile arrests were processed primarily by means of a rather cumbersome paper-based system. To ensure more accurate record keeping and gain greater analytical capabilities, as well as to comply with the 1998 amendment to the State of Illinois Juvenile Court Act of 1987, the department has implemented an expanded Juvenile Arrest System as a CLEAR application.

Prior to launching the enhanced Juvenile Arrest System, the CPD stored in CHRIS basic information about juvenile cases handled through the court system. Data entry clerks would input information from paper reports filled out at the time of the juvenile's arrest. In addition to being inefficient and redundant, this process also did not capture data about station adjustments – the immediate resolution of a juvenile offense with conditions imposed on the offender by a youth investigator. This is a frequent outcome of juvenile arrests and a focus of the 1998 amendment. Station adjustment paperwork was kept in a file at the stationhouse where the juvenile was processed. To access information about station adjustments, officers needed to call the appropriate district to request a check of the paper records. With 30,000 juvenile arrests and thousands of station adjustments each year, this method proved to be very ineffective and left the CPD with no real means to accurately track a juvenile's compliance with station adjustment stipulations. This method also made it very difficult to maintain station adjustment records that were mandated by the 1998 amendment. It specifies that a) no more than nine station adjustments can be granted to an offender without state's attorney approval (though the CPD's threshold is three); and b) station adjustments must be reported to the State Police for offenses that would be felonies if committed by adults.

To comply with these requirements, the CPD decided to expand its youth processing system by designing Web-based, interactive juvenile-arrest data entry screens that would capture the mandated information and whatever additional data were permissible within the constraints of juvenile rights legislation. The CPD's main goal for the enhanced Juvenile Arrest System is to track and assess the conditions and outcomes of juveniles as they move through Chicago's juvenile arrest system. The new system allows officers to check a juvenile's record for outstanding warrants, missing reports, demographic information and criminal history, including summary of arrests, arrest charges, court charges and mug shots. However, only youth investigators, supervisors and detectives cross-trained in youth arrest procedures can access the data entry screens to process a juvenile offender. A new feature of the enhanced system is that youth investigators now are able to save their work-in-progress, allowing officers to resume working or update case reports at any computer connected to the CPD intranet.

Development

Development of the enhanced Juvenile Arrest System evolved over the last four years and has involved many participants, each with distinct responsibilities. The CPD's Data Systems director of development oversaw the project, while programmers from the Oracle team created the actual juvenile arrest screens. The commanding officer of Youth Investigations Administration headed a five to 10 person team responsible for many facets of Juvenile Arrest System development including: design review, testing and evaluation, recommendations for change and user training.

The department's original intention was to launch a system that would meet or come close to the state's amendment compliance date of January 1999. In November 1998, the CPD expected to be in compliance by March 1999. However, this deadline was not met and was revised numerous times due to CPD and the Oracle team personnel departures, funding shortages

and other data systems matters (such as Y2K security) that took precedence. According to a key insider, there were no repercussions for missing the compliance deadline; the State of Illinois decided to turn a blind eye to the deadline because jurisdictions statewide were unable to meet it as well. However, the CPD did its best to comply with the new requirements through its existing paper-based system, but without an automated system, the attempt fell short of satisfying the true intent of the law.

Over time, 16 joint application development (JAD) sessions were held with representatives from Data Systems, Oracle and the Youth Investigations team. The sessions took place between August and December 2000, resulting in a process model that mapped out the paper-driven juvenile arrest process in its entirety. The process model, an elaborate flow chart showing possible decision points and associated procedures in the arrest process, would serve as the foundation for development of the application. However, as 2001 began, development of the expanded juvenile system was put on indefinite hold for many of the same reasons that led to its previous delay. In April 2002, the development of the juvenile arrest screens began anew, with both the commander and commanding officer of Youth Investigations brainstorming to determine the best way to get development of the expanded Juvenile Arrest System back on track. They decided to create a six-person focus group comprising youth investigators from the various Chicago Police Department Areas. Over the course of the next five months, five focus-group sessions were held, at which participants recommended changes and improvements to the juvenile arrest screens. Their recommendations were subsequently passed on to Data Systems developers and Oracle programmers for implementation. A working model of the enhanced juvenile system was made available for testing by users in two Area headquarters, CPD headquarters and the Special Investigations Unit, with the intention of eliciting user feedback. Unfortunately, due to their heavy workload, investigators in the field never used the test model and, therefore, no feedback was generated. The Youth Investigations team nonetheless felt very confident of the final product, and despite having no user feedback, they decided to progress with the training and implementation of the enhanced juvenile arrest application.

Training. A six-person team made up of youth investigators conducted training for the enhanced juvenile arrest system in September 2002. Training consisted of a three-hour class for the department's 250 field youth investigators, 60 headquarters Youth Investigation staffers, and supervisors and detectives who have been cross-trained in juvenile arrest procedures. Sessions were held at CPD headquarters on each watch, with a maximum capacity of 18 participants per session to ensure that each officer had a terminal on which to work. Early training sessions were well-attended, averaging eight to 10 officers per session for the first two weeks. However, attendance dropped off considerably by the end of the second week.

Training sessions were held in the Data Systems computer lab at headquarters. Participants were instructed via two large monitor screens that mirrored the training screens being used by participants. The three most frequently used functions were covered in-depth, while a few others were briefly examined. Each attendee received an extensive training packet as well as a Juvenile Arrest Menu "cheat sheet" and a small packet of printouts from the new system.

Instruction concluded two days before the system was launched citywide, with approximately 80 percent of Juvenile Arrest System users having attended a session. Youth officers who had served as trainers returned to their districts, where they were expected to train those who were unable to attend formal training at headquarters. The Data Systems Help Desk was trained in the technical aspects of the enhanced Juvenile Arrest System and is available for users who have technical questions about the new arrest screens. However, all juvenile arrest processing questions must be handled by Central Youth Activities at CPD headquarters, which is staffed around the clock and can help guide officers through the processing of youth offenders.

Implementation and Impact

The citywide launch of the enhanced Juvenile Arrest System occurred on September 30, 2002, when it became the primary method for processing juvenile offenders. Early feedback indicates that the rollout went well. Some bugs surfaced, but they were basic malfunctions (could not print; button did not work) that were remedied by officers in the field calling the Help Desk or the juvenile arrest liaison (a Youth Investigations officer at CPD headquarters), who contacted Data Systems programmers to coordinate efforts to solve the problems. Solutions requiring a policy decision are taken to the commanding officer of Youth Investigations.

Those most impacted by the new juvenile arrest application are youth investigators, designated detectives and, to some extent, arresting officers who now follow a slightly new procedure. A key CPD insider stated that “responses have been pretty positive,” stressing that this is not a completely new system, but rather an enhancement and expansion for which most of the hurdles in making the transition from paper to the computer have already been cleared. In addition, the changes – including the final look and feel of the new juvenile arrest screens – were closely scrutinized by officers who would use them on a daily basis.

Youth Division administration will need to develop a course of action for juveniles who do not comply with station adjustment stipulations. Prior to the implementation of the new Juvenile Arrest System, the department did not know whether juveniles were actually complying with station adjustments, so no action was ever needed. Now, compliance with station adjustment conditions will be trackable, and a course of action for noncompliance must be devised. It is expected that the appropriate action will be taken via the juvenile court system, but the action plan has not been finalized.

The CPD has not encountered any major obstacles in implementing this application and does not expect to in the future. Sergeants’ complaints are anticipated, because the scope of their report review and approval responsibilities has been expanded. Under the enhanced Juvenile Arrest System, sergeants are required to thoroughly read each report for accuracy and completeness before approving it. Another concern voiced by users is that it might be more time-consuming to process a juvenile’s arrest under certain circumstances. For example, at one training session an officer proposed a scenario in which several juvenile offenders would need to be processed at the same time. The officer believed it would be a lengthy process to complete all

required fields for each juvenile and that it could be difficult to gain access to a computer in stationhouses with limited computing resources.

The Future of the Juvenile Arrest Application

Currently the enhanced juvenile arrest application is solely being used within the CPD, though developing an interface with other all juvenile arrest systems within Illinois is being considered. The State of Illinois has expressed interest in the possibility of replicating the CPD's new Juvenile Arrest System statewide. Another future use being examined by the CPD is incorporating some of the analysis that will be done with the new juvenile information into beat community meetings, especially if residents of a specific beat show interest in juvenile arrests and request information that can be shared.

Organized Crime System

The Organized Crime application is a component of the Criminal History Recording Information System (CHRIS) case reporting application. Organized Crime units will use this application to capture vice case-reporting incident data and to create supplemental reports.

Development and Implementation

Data entry screens were developed more than a year ago for this application and currently the combined Oracle/CPD development team is working toward implementation. The screens were demonstrated for the Organized Crime Division (OCD) personnel at a meeting in late October. Modifications identified were in the area of narcotics property and the supervisors' "in box." The narcotics property modification deals with money that is taken for the purpose of "buys" by OCD. The division wants to identify each unit of currency that is taken out for buys by serial number, a function that cannot be accomplished under the current system. Additionally, the supervisors' in box needs to offer a greater range of options to make it useful for the various units within the division, such as narcotics, vice and prostitution. The current application accommodates only one way for supervisors to enter data, which does not allow all units to complete their task.

The intention is to implement the screens as soon as possible, but the actual timeline is dependent upon approval of the modifications identified at the October meeting. OCD is not moving forward with the current client-server system because it would require training more than 300 personnel on a format ultimately to be replaced by HTML. Instead, the division will wait until the Patrol Division's automated incident reporting application (AIRA), described earlier in this section, is completely operational, then move the OCD module into HTML format and conduct training for the 300 officers who will use the application. There will, however, be HTML supplements developed in OCD for some of units within the division.

The Future of the Organized Crime Application

The goal of the Organized Crime Division application is to establish a natural flow of data into the CHRIS reporting system and, eventually, into the data warehouse. What was once accomplished manually by OCD officers will be automated through the OCD data entry screens. Data entry will eventually be conducted via PDTs or any workstation with access to the CPD intranet.

Personnel Suite

The Chicago Police Department is institutionalizing its accountability initiative (discussed in full in an earlier section of this report) with the development of the Personnel Suite, an automated system that will track and monitor personnel data. Included in this application is a module known as the Personnel Performance System – an early warning system – that will identify problem behavior before it results in an unfavorable outcome.

The Personnel Suite will automate human resource functions in five of the department's units: Finance, Internal Affairs, Office of Professional Standards, Medical and Personnel. Data pertaining to behavior monitoring and performance will be collected in the Personnel Performance System, as shown in Figure 26.

Figure 26
Personnel Suite Overview

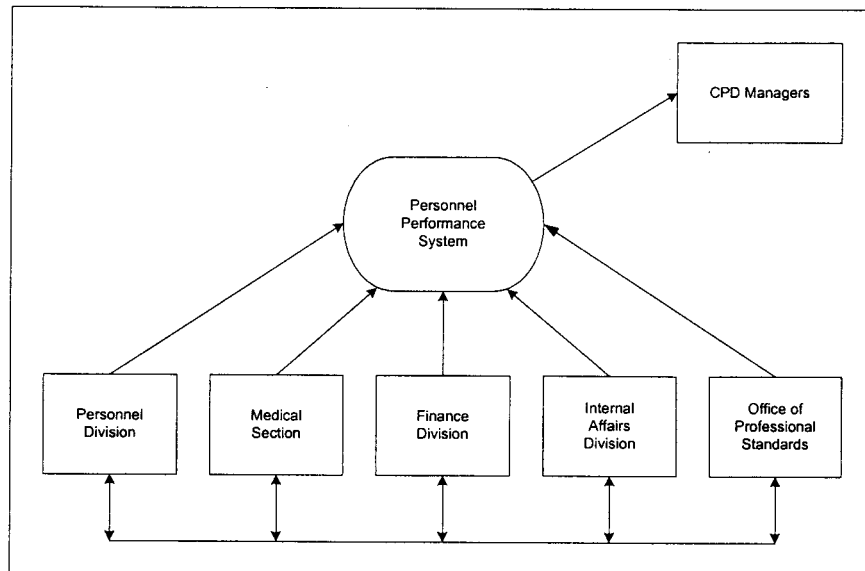

Automating the Units

Finance Division. A few of this division's functions are currently automated through CHIPPS, which is a stand-alone system used by City Hall's Department of Personnel, but tracking of time and attendance – one of the Finance Division's core functions – is not. The Personnel Suite will computerize the tracking of time and attendance, which is now maintained individually by unit. Currently, time and attendance records are transferred to the Finance Division, with data eventually ending up at City Hall for payroll functions. Because this information is not automated, the department is unable to obtain real-time information about manpower strength which, under any circumstance, is essential. In the present climate of ongoing terrorism threats, real-time information that is immediately accessible is absolutely necessary to ensure effective deployment in the event of an incident. In addition, the system will automate basic timekeeping tasks, such as transmitting time slips electronically. Managers will benefit by having data available to help them approve vacation and time-off requests based on anticipated manpower levels, and officers will be able to track their vacation, furlough, sick time and overtime allotments.

Internal Affairs and Office of Professional Standards. The Personnel Suite application will enable these units to easily access information for complaint investigations. At this time, each of these units has its own investigation assignment and tracking system. Personnel Suite will eliminate redundant processes of these two units and ensure that duplicate complaints are not filed. In addition, the application will provide access to time and attendance records, which are essential for determining whether an officer was on duty at the time of the incident, as well as provide access to arrest and case reports relevant to the consequent investigations.

Medical Section. This unit's myriad functions related to medical leave and injured-on-duty (IOD) status will be directed by the Personnel Suite. Currently, a complex and laborious manual process tracks and regulates this massive subgroup and, as a result, manpower strength data takes up to three days to calculate. Under Personnel Suite, real-time force level numbers will be accessible.

Personnel Division. Some of this unit's functions are handled through the Chicago Integrated Personnel and Payroll System (CHIPPS). This system will continue to handle its current CPD functions, such as generating payroll, and will not become a part of CLEAR. However, other Personnel Division systems such as Star Management, Tuition Reimbursement and Applicant Investigations (background checks) will be automated and managed within the Personnel Suite.

Personnel Performance System. This portion of the Personnel Suite will be a repository for all data related to officer behavior and performance, which will drive the early warning system. The Personnel Performance System will interpret the information to identify officers whose performance indicates potential problems as a result of recurrent citizen complaints, pursuits and traffic accidents, firearm-discharge incidents and the like. Officers so identified are provided with intervention (counseling or training) designed to correct the problematic behavior.

While this is currently done on a manual basis, the Personnel Suite will widen the scope of the data employed and systematize the problem-identification process. Development of the CPD's early warning system is not the result of a consent decree; however, U.S. Department of Justice recommendations for jurisdictions so mandated will anchor Chicago's program.

Development and Implementation

At the time of this report's writing, Personnel Suite applications were all advancing through developmental stage, putting them squarely on schedule. Progress of each application is as follows:

Finance's JAD sessions got underway in early autumn, and the process description document was completed at the end of October 2002. This segment of the Personnel Suite is not expected to be as complex as some of the others.

Internal Affairs' portion of the Personnel Suite is nearing the end of the developmental stage. Five JAD sessions have been held, and the document mapping out current functions is almost completely written.

Office of Professional Standards' application is almost at the end of development, with its five JAD sessions having been held over a three-month period. Its formal description document is currently being prepared.

Medical's first round of JAD sessions was held in early autumn 2002, with the process expected to be completed by year's end. The process mapping document is scheduled for completion shortly thereafter.

Personnel's segment of the Personnel Suite has reached the end of the JAD phase – sessions have been held, and the process mapping document has been written. At this time, departmental acceptance is awaited.

The **Personnel Performance System** remains in the conceptual stage, mainly because the other applications from which essential personnel data are extracted must be developed first.

The Personnel Suite has gone through the subcontracts stage, having a signed contract with the Police Executive Research Forum (PERF). PERF will be helping the CPD identify best personnel practices and policies from the public and private sectors nationwide in the human resources areas the suite will encompass.

Because of the widespread impact of this application and the sensitivity of the information it will manage, the superintendent of the CPD has convened an oversight committee that will make recommendations and help guide the direction and development of the Personnel Suite. Composed of 11 key administrators and chaired by the CLEAR project manager, the committee will review and evaluate PERF's findings for applicability and appropriateness within

the CPD and guide the institutionalization of new personnel-related policies and procedures. As part of their duties, committee members will visit three sites where early warning systems have been implemented to gather their own intelligence on best practices. In addition, the oversight committee intends to host a mini-conference composed of private sector chief information officers, IT professionals and human resource administrators to share ideas and consider best practices from their vantage points.

Though development costs for this multi-dimensional system will be substantial, funding has not been a problem for the Personnel Suite thus far. While the Personnel Suite project manager is mindful of the plentiful funding needed to fully implement this application, she remains hopeful that continued grant-seeking vigilance will augment the money already earmarked by the department for the application's development. And, because there will be no hardware expenses associated with the Personnel Suite, there will be no "bottlenecks" related to identifying vendors, seeking proposals and engaging in the bidding process.

At the writing of this report, it was not clear which subsystem of the Personnel Suite would be implemented first. There are factors that would point to some being developed prior to others – for example, the Medical Section application is somewhat independent of the others, and its impact and benefits would be far-reaching. At the same time, a less complex system like the Finance application might possibly be completed very quickly, making it an attractive candidate for early completion. Decisions will be made when each of the subsystems' as-is document is completed. Because of the complexities of this application's subsystems as well as the depth of research to be undertaken before developing them, the target for completion of the Personnel Suite is about three years.

The Future of the Personnel Suite

The Personnel Suite can almost be considered the future of the CPD. While it is only a part of CLEAR, it is a vital system that will help the department strategically deploy personnel; create accountability standards; identify problems within the ranks and offer early intervention; and remain poised to effectively address terrorism threats.

A byproduct of automating the organization's human resource functions will be the ongoing need to address policy issues related to the collection, use and dissemination of data. The demanding task of developing and establishing sensitive, ethical policies is providing the department with the opportunity to incorporate its best practices findings and policy-making experiences into a document that can serve as a model for other jurisdictions planning to implement automated personnel systems and early warning programs.

Traffic Crash Report Routing System

The CPD is developing a comprehensive traffic crash report-related application composed of three modules. One module will automate the traffic crash reporting process and wirelessly transmit reports from officers' PDTs directly to appropriate department units and the

data warehouse. A second module will feed traffic crash report information to the Major Accident Incident Section (MAIS) for followup investigations. An application that automates traffic crash report retrieval and fulfillment of requests for report copies is the third module of this system. Initial-stage development of this application, known as the Internet Crash Report Retrieval System (ICRRS), is underway.

Background

On average 500 to 700 traffic accidents occur each day in Chicago, with each accident usually producing multiple report requests. The majority (60 to 70 percent) come from insurance companies, and the remainder are from internal units within the CPD, city agencies, private citizens and other law enforcement agencies. Under the CPD's current process, labor costs for report processing and retrieval are very high: the department employs approximately 36 workers to process, read, code and make 62 million photocopies per year. To offset this expense, the department charges a \$5 fee per traffic crash report copy.

Two years ago the CPD began electronically scanning the traffic crash reports and storing them in Tagged Image File Format (TIFF). These files – essentially photographs of accident reports – are stored electronically but function as copies rather than interactive documents.

Goals for the Internet Crash Report Retrieval System

The CPD would like to make its traffic crash report retrieval system more efficient, economical and customer-friendly, and plans to eventually create the ICRRS. The department has three goals for the new system: get out of the “printing business,” reduce the number of individual requests from the three main stakeholders, particularly insurance companies; and eliminate the need to retrieve reports for city agencies.

The benefit of developing the ICRRS, in addition to providing customers a more user-friendly system, is an approximate 158 percent return on investment over the first five years of the system's use. The efficiency of the ICRRS is expected to reduce insurance company report requests by 50 percent, consequently reducing the CPD's personnel needs by 25 to 35 percent. In essence, the ICRRS has the potential to automate a substantial portion of the report-retrieval process and drastically reduce the CPD's labor cost.

Development and Implementation

A former police officer now serving the CPD as a civilian traffic analyst was brought onto the Information and Strategic Services team to improve and automate the traffic crash routing system. The analyst began redesigning the traffic crash reporting system in early 2002 by meeting with representatives from insurance companies to listen to their suggestions for a new report retrieval system. The analyst also met with the CPD's Records Division director and processing staff, at which time the director summed up the situation by saying, “The #1 problem

is making the damn copies.” Network managers were also interviewed to discuss security issues surrounding a new crash-report-retrieval system.

After extensively reviewing the current crash report process, the analyst identified three main options for improving and automating the system: 1) create a limited-information, stand-alone crash report database that will not compromise CHRIS security; 2) adapt to CPD specifications a paperless application being developed by the Illinois Department of Transportation (IDOT) that will enable the state police to input crash information on their PDTs and wirelessly send reports to a server to be stored; or 3) develop a CHRIS-linked system requiring minimal changes to interface efficiently with the current setup in the Records Division.

In March 2002 the analyst recommended the CHRIS-linked system option – the ICRRS – to the executive administrator of Information and Strategic Services. The ICRRS requires only minimal changes in Records Division procedures, with personnel needing to sort traffic crash reports into categories based on the type of incoming report and organize them by number of pages (one-page reports together; two-page reports together, etc.). Reports would then be scanned as electronic files (TIFF images), updated with any extra data or graphics and stored on a server. Finally, the reports would be coded with a letter to indicate which city department or agency should get the report (W for Department of Water, for example), copied and distributed. The ICRRS would also attempt to make the new crash report and retrieval process “user-friendly for business clients (insurance companies) and the man on the street” by being accessible online.

The online option requires major upgrades to the current system but will allow a report-seeker to go to the City of Chicago’s Web site, follow the link to the CPD’s Web site and, once there, click on the ICRRS link. After users identify themselves as having been involved in an accident, as insurance company representatives or as City of Chicago agency employees, they will input the crash incident number, and the system will search for the scanned reports. Once found, the system displays a portable document format (PDF) file link on users’ computers. After paying the \$5 fee by credit card, report-seekers can view, download or print reports as PDF files. The single-report method is for customers seeking one crash report. For insurance companies requesting hundreds of reports at a time, the system delivers them in batches of 100.

The Internet Crash Report Retrieval System has two hardware/software options. The expensive option is to use either a top-of-the-line UNIX solution or a comparable Microsoft solution, with the main benefit of the UNIX system being that it would make use of a Web server the CPD already owns. A much less costly option would be for the CPD to purchase a small server that would handle the ICRRS and a few other small CLEAR applications. The fact that the ICRRS is not supported by the current CPD hardware/software is a concern, because the majority of bottlenecks with CLEAR applications are due to contracting with an outside vendor for hardware and software delivery and support. Whichever option is pursued, there will be some security concerns related to the way the ICRRS delivers information to various users via the server. While the analyst cautioned that “there are no unhackable systems,” the plan is for the ICRRS to use a highly secure component object model (COM), a bypass that allows the CPD to increase security by controlling the flow of data.

As of October 2002, the Internet Crash Report Retrieval System was still awaiting approval from the executive administrator of Information and Strategic Services, and funding is not currently available to allow the analyst to hire a small staff of graduate students from a nearby university and begin development of the ICRRS. According to a CPD informant, only the criminal justice components of CLEAR have been budgeted and have funding for development. Community-Business Partnership components (of which the ICRRS is one) are not yet funded, and it is unclear when funding will be available.

Training

Training will not be needed for this “front-end” portion of the ICRRS, because the analyst believes that proposed changes to the Records Division Web site are self-explanatory, and only select CPD employees will need instruction. Training will be needed, however, for those responsible for long-term maintenance of the ICRRS.

Pilot-testing of the ICRRS is also not an issue at this point, but the current thinking is that the first step will entail Data Systems running the application on the CPD intranet and attempting to breach its security. It is also likely that the pilot model of the application would be opened up to insurance companies for user-friendliness testing.

Implementation and Impact

With sufficient staffing and funding, the analyst believes the application can be developed and launched within three to six months. When implemented, the ICRRS will most impact the department and insurance companies. The CPD will improve efficiency and save money, while insurance companies that “want it badly,” according to a CPD informant, will enjoy a “greatly streamlined process,” likely eliminating their need for outside retrieval services. These retrieval companies charge a fee to insurers to handle the laborious process of picking up batches of accident reports and bringing them back to the insurance companies.

The Future of the Internet Crash Report Retrieval System

At the time this report was written, a target date for completion of the Internet Crash Report Retrieval System was uncertain; much depends on the still-to-be-determined development priorities for each of the Traffic Crash Report Routing System modules.

Looking toward the future, the CPD has been approached by the Cook County Clerk of Courts about data exchange. The Clerk’s office would like to send every traffic incident report to the CPD, giving CPD officers access to all traffic tickets written in Cook County. Having access to all of the county’s automobile-related records could be helpful for investigators having difficulty tracking down a person and for those wishing to access up-to-date information on countywide DUI arrests.

Adjunct Projects

Hyper Text Markup Language (HTML) Conversion

A goal of creating CLEAR is to bring the CPD's various computer applications into one integrated system that enables each module to interface with the others, eliminate redundancies and function in an integrated fashion. To realize this goal, more than a dozen pre-CLEAR applications must be converted from their original operating environment – client-server – to hyper text markup language (HTML), CLEAR's Web-based operating environment. HTML conversion is perhaps the most far-reaching and least visible aspect of CLEAR development.

HTML is "quicker, better and cleaner" than CHRIS's current client-server platform, according to one informant. Among HTML's advantages is that it allows systemwide modifications to be made to applications by means of programming changes from one central location rather than at each workstation site, as is required in a client-server environment.

Typically, when a legacy system is in the process of being converted, updates and enhancements are made to the application, based on focus group input and "user wish lists." Conversion of the legacy systems to HTML requires the development of business logic for each.

HTML conversion, headed by a CPD project manager working with an Oracle project manager, began in January 2002. The entire project is expected to take 35,000 hours to execute; the target completion date is summer 2003.

Integration of Criminal Justice Information Systems

This aspect of CLEAR calls for developing a system that provides for a flow of data between the CPD and more than 120 agencies in the Chicago area, including law enforcement, prosecution, courts, corrections and "other interventions" (presumably not criminal justice agencies) yet to be specified (see Figure 27). The main goals for Integration of Criminal Justice Information Systems are stated as: "enable unified strategies to reduce crime, eliminate criminal justice system 'bottlenecks,' increase accountability among criminal justice agencies and provide a complete picture of offender activity." The CPD believes that an integrated system would add value in terms of reducing crime and labor, as well as increasing the number of cases solved. Specifically, an integrated system would improve the capacity to "police smart," share development costs, allow for single-system maintenance, reduce administrative labor costs, improve employee morale, strengthen relationships with the community, reduce liability costs and enhance the Chicago Police Department's reputation as a technology leader.

Figure 27
Criminal Justice Information Sharing

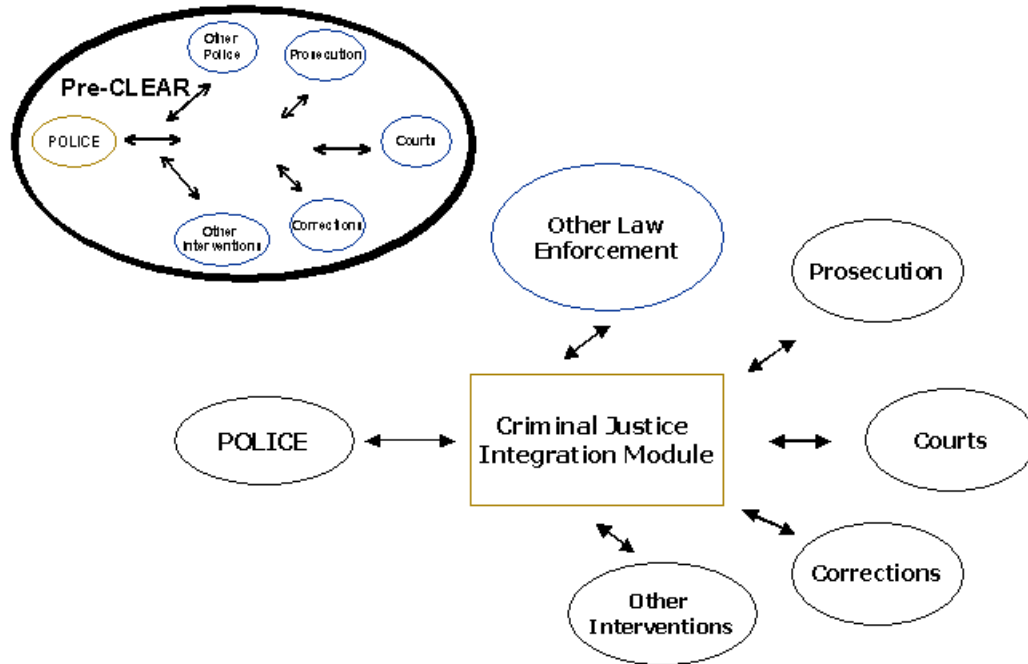

The CPD conducted an 18-month impact analysis for one of its divisions within an integrated criminal justice model and found that its clerical work force could be reduced by 227 and its technical work force by seven, thus producing an annual savings of \$8.7 million. The analysis also concluded that 90 officers could be redeployed to the streets of Chicago. These findings, along with the department's enthusiasm for a truly integrated criminal justice system, are moving this CLEAR application forward.

Research on the Implementation of Integrated Criminal Justice Information Systems

A great deal has been written about the benefits of implementing an integrated criminal justice system, providing reasons why such a system would be advantageous to many. It is claimed that faster data sharing among agencies would lead to quicker arrests, facilitate faster processing of criminals, expedite court cases and prevent crime. Such a system also would be of invaluable assistance in the case of a disaster, be it natural or manmade.

However, many complications that can impede development of such a system have likewise been identified. For example, for agencies to share data, they must systematically collect and enter identical data elements and use compatible computer systems to ensure smooth data transmission. Historically, agencies have set up stand-alone systems and collected data

useful solely to them. Because data entered into individual systems can also be incomplete or inaccurate, linking such systems can be highly problematic. And many lack a governance structure and function as individual agencies.

Governance boards provide project review, implement initiatives, set policy, recommend funding, set standards, prioritize system changes and authorize software changes. However, the development of a governance board is often fraught with agency turf issues or dissolves in a political tug of war. The development of a governance structure needs the stewardship of someone who can champion and market the need for an Integration of Criminal Justice Information Systems effort; garner unconditional support from county, city and elected officials; and motivate others to jointly conduct strategic planning and consensus building. This can be challenging when there is scant natural consensus-building among jurisdictions or the politicians who serve them. Furthermore, if all stakeholders are not brought to the table during development of a governance board, there is likely to be diminished cooperation, buy in by participating agencies and, ultimately, trust among them. Eliciting agency participation in the development stage is a critical part of governance board evolution. Agencies not involved at this stage historically have strong concerns about changes that might result from having a governance structure and are less likely to support establishment of such.

Funding constraints also contribute to agencies' reluctance to get involved in data sharing. Smaller agencies often lack the resources or funding to purchase adequate computing systems, and may not be able to employ the technical support needed to run and maintain them. Other agencies cite privacy issues and data misuse as reasons for not participating in a fully integrated data-sharing program. While federal funding is available to alleviate smaller agencies' resource problems, many of those jurisdictions use the funding to further develop and improve systems that are specific to their agency and, therefore, make no progress in the data-sharing arena.

Among the larger questions in the creation of a integrated criminal justice system are: Who decides what data are important? Who controls the data? Who ensures that adequate quality-control mechanisms and safeguards against data misuse are in place? While the reasons for developing an integrated criminal justice system are highly convincing, the reality of doing so can be highly discouraging.

Chicago's Criminal Justice Information Systems Integration Project

The CPD has launched an Integration of Criminal Justice Information Systems recruitment effort headed by a retired lieutenant who now serves in a civilian capacity. The primary thrust of this project is to involve other jurisdictions in providing their data (mug shots, fingerprints, case reports) to the Cook County Sheriff's Criminal Apprehension Booking System (CABS). CABS is the central repository for the above-mentioned information from Cook County agencies outside the City of Chicago, and its data are transmitted to the CPD's data warehouse. Currently participating are 107 police departments, the Cook County Sheriff's Office and the Illinois State Police, all providing ongoing data, the earliest dating back two-and-a-half years.

The head of the Integration of Criminal Justice Information Systems project spends considerable time visiting nonparticipating agencies to make presentations demonstrating the capabilities of the data warehouse. Additionally, discussions have started at the federal level with the Secret Service, DEA and FBI to elicit their participation. Though the CPD believes that criminal justice information integration and the formation of a governance board should be spearheaded by the State of Illinois, to date such efforts have not progressed beyond the discussion stage. The CPD is not willing to wait for that to come about, so it is moving ahead with criminal justice information integration activities with its current resources and is not seeking to develop a governance board.

There has been, however, an inter-governmental agreement entered into between the Cook County Sheriff's Office and the Chicago Police Department. About two-and-a-half years ago the Sheriff's Office obtained funding from the Office of Community Oriented Policing Services to help Cook County suburban and city police departments acquire Livescan fingerprint equipment, which enables them to scan fingerprints, as they are captured, into the Automated Fingerprint Identification System (AFIS).

Currently, most agencies that have partnered with CABS have no direct results from their participation; the payoff is down the road, when they will be able to tap into the CPD extranet to get online reports, detective information and streaming video training. However, the department has launched a pilot test, selecting six Cook County police departments to have extranet access to the CPD's data warehouse. The data warehouse contains 12 years of Chicago Police Department data and, as mentioned previously, two-and-a-half years of data from the Cook County Sheriff's Office, the Illinois State Police and the 107 participating Cook County police agencies. At this point, pilot test areas have access to the CPD's online reports. Figure 28 shows the offerings available to pilot-test agencies. There is ongoing discussion about extending access to the Automated Directives and Streaming Video Training menus. A potential problem of offering expanded streaming video training access is that participation of too many agencies might tax the department's bandwidth capabilities.

Each of the pilot users has a unique ID, based on the National Crime Information Center (NCIC) numbering system. Participating agencies log on through the CABS network, and key in the identification number, which is specific enough to check the integrity of users by agency and by person. If problems arise from one particular agency, more training or technical assistance will be provided. The CPD is currently providing training to users at the six pilot sites. Each police agency determines who will use the system as well as who will receive training. Some agencies only want specific individuals to have access to the system, while others want it available to the entire department.

Figure 28
Pilot-Test Agencies Menu



Chicago Police Department Extranet Services

Table of Contents	
↓ Automated Directives *	↓ Department Telephone Directory
↓ Bureau of Administrative Services	↓ E-Mail Addresses
↓ Bureau of Investigative Services	↓ Internet Links
↓ Bureau of Operational Services	↓ Office of the Superintendent
↓ Bureau of Staff Services	↓ Online Reports *
↓ Bureau of Technical Services	↓ Site Map - Alphabetical
↓ CHRIS Project	↓ Site Map - By Bureau
↓ Data Warehouse	↓ Software Download
↓ Department Organization	↓ Streaming Video Training *



Chicago Police Department



"Safe Neighborhoods Are Everybody's Business"

© Chicago Police Department, 2002

In terms of criminal justice agency integration, the CPD is only involved with other law enforcement agencies or institutional police forces, such as those at universities and hospitals. This is due to the fact that the data currently being shared are related strictly to arrest and case reporting.

The CPD envisions a second phase of criminal justice agency integration that will involve the Law Enforcement Automated Data System (LEADS) and NCIC developing a governing board, especially to address privacy issues. Though the Illinois governor mandated that the Illinois Integrated Justice Information System will provide an as-yet-unspecified number of people to help implement data sharing, the CPD is not optimistic that this will come to fruition in the foreseeable future. Thus, the department is moving ahead on its own to realize its vision.

One of the impediments that the department has come up against with this system, according to one key person's experience, is that "all roads lead to firewalls," meaning that a central pipeline needs to be created for universal participation. Other obstacles to full implementation of agency integration include problems related to limited transmission bandwidth as well as the Data Systems Division's current heavy workload.

The Future of Criminal Justice Information Integration

The CPD continues to visit collar county agencies, hoping to continue to bring them "on board" through their participation in data sharing through CABS – data that will ultimately reside in the data warehouse. While the CPD currently has 109 partners, the goal is to have 132 agencies involved by 2003. The vision is that the data warehouse will become the main database for all types of criminal justice information and that all participating agencies will become proficient at using the data for crime-prevention and crime-solving efforts.

National Incident-Based Record System (NIBRS)

The federal government began to systematically collect crime data in 1929 through the Uniform Crime Reporting (UCR) program, which produces counts of specific types of offenses. This program remained unchanged until the mid-1980s, when it became evident that collecting a greater range of incident-related information would provide a more accurate picture of criminal activity as well as a more robust database from which to perform crime analysis. Due to UCR's aggregate structure, there is no method by which offenses can be linked to arrests and, likewise, clearance information cannot be linked to information about arrestees. To address this, in 1988 the federal government introduced a new reporting system called National Incident-Based Reporting (NIBRS). The unique feature of the NIBRS is that collecting richer data at the time of arrest allows for individual records on each reported incident and its associated arrest. NIBRS moves beyond aggregate statistics and raw counts of crimes and arrests to look at details of an offense, such as offender, victim, property, weapons used and other essential arrest data.

A multi-year evaluation of UCR resulted in the 1985 publication "Blueprint for the Future of the Uniform Crime Reporting Program," which presented guidelines and specifications for NIBRS. Though more than 15 years have passed since the Blueprint recommended NIBRS as a reporting system that would serve law enforcement's future needs, to date only 11 percent of the U.S. population is represented by agencies using the system.

Research on the NIBRS System

Numerous studies, focus groups and surveys have been administered to ascertain why NIBRS is so underutilized, and recommendations have been made for helping law enforcement agencies adopt the system. In 1997, the Bureau of Justice Statistics released a document entitled "Implementing the National Incident-Based Reporting System: A Project Status Report," in which seven major impediments to NIBRS reporting are summarized:

Funding. Many agencies lack the software and hardware required to capture the new data fields required by the NIBRS system, and neither do they have the resources required to keep up (inputting, maintaining quality control, processing) the significantly increased volume of data nor the personnel to train employees on an entirely different and more complex system. This affects both small law enforcement agencies that may be using a simple stand-alone computer doing little more than word processing as well as larger departments with costly legacy systems that cannot accommodate NIBRS data fields.

Uncertainty about the benefit of NIBRS. Law enforcement agencies throughout the nation have yet to be convinced that NIBRS compliance will benefit them significantly. NIBRS has long been viewed as a statistical tool for researchers rather than one for law enforcement and crime fighting. Therefore, most departments consider the system to be one that requires increased work with few tangible benefits.

Policy concerns. Law enforcement officials fear that crime will appear to be on the increase under NIBRS. Because the new reporting structure records multiple offenses for one incident – an incident that under UCR is reported as one offense – an inevitable result will be that crime will appear to be worsening. And in a similar vein, agencies have expressed concern that no definitive policy has been adopted that would prevent comparison of UCR crime incidence figures with NIBRS data. Such comparisons are unacceptable because the programs differ so dramatically.

Administrative issues. Because officers will be required to spend more time at a crime scene to capture the data required for NIBRS, administrators foresee officers having less time to respond to residents' needs. In addition, agencies are concerned about having the available resources and time to train officers and hire technical support for this new system.

Reporting requirements. Law enforcement agencies consider NIBRS compliance to be a complete change in the way they do business, forcing them to meet a number of new regulations that, as mentioned before, are viewed as burdens rather than benefits to them. Some have called for more flexibility in NIBRS reporting, which is currently perceived as requiring “all or nothing” participation. However, to date the federal government has only indicated a willingness to work with agencies and has not actually created a change in the method of reporting.

Data elements questions. Law enforcement agencies are not completely convinced about the value of collecting some of the required data elements – elements they believe have no investigative value.

Education needs. Key agency decision-makers and stakeholders alike will need comprehensive education to gain an appreciation of the usefulness of an incident-based system. Complementing this instructive program should be an awareness campaign aimed at the media, the business community and the public at large to demonstrate the nature, objectives and benefits of the multi-dimensional reporting system.

To many, the far-reaching implications of this list of concerns appear to provide more reasons for excusing law enforcement agencies from becoming NIBRS-compliant rather than for their joining in. The federal government, for this reason, has shown keen interest in Chicago's progress in converting to a NIBRS-compliant agency.

Chicago and NIBRS Compliance

The responsibility of NIBRS-compliant reporting falls on the State of Illinois, which will require that all jurisdictions in the state become NIBRS-ready. Statewide participation is likely to take some time, because many smaller departments are currently not ready to change from UCR and will not be in the near future. The CPD, however, has identified early 2003 as a target date for becoming NIBRS-compliant. This does not mean that NIBRS data will be reported to the federal government; however, the department will be collecting data according to NIBRS specifications.

Fifty-three data elements will be extracted from the CPD's Criminal History Recording Information System (CHRIS). Information to populate NIBRS data fields will enter the system via the Automated Incident Recording Application (AIRA), which prompts officers to collect richer data elements when completing incident reports. An extensive evaluation revealed that hundreds of new CHRIS data fields and tables are required to accommodate the information entering the system via AIRA. The CPD's enhanced CHRIS 2.0, expected to be complete in early 2003, will be reconfigured to provide all of the data for NIBRS compliance.

Oracle Corporation is responsible for the programming changes needed to accommodate the new reporting structure, and there is an officer assigned to deal with all technical matters, as well as one to conduct process mapping to illustrate how the new system will impact all parts of the organization. Training will be conducted in modules at the appropriate time, and an analyst in Research and Development will develop a plan for determining how crime information is to be disseminated to the media when and if the data are reported. As stated earlier, the timetable for collecting the data is early in 2003, but actual data reporting is highly dependent on the ability of jurisdictions statewide to become NIBRS-compliant.

Training. NIBRS reporting will not be singled out as a separate training piece; rather it will be incorporated into district-level AIRA training for police officers, as well as into the curriculum for upcoming lieutenant and captain training. Trainers will mention NIBRS to the supervisors as AIRA begins to move out to the field, but they will not announce, "you are now going to collect new data for us to be NIBRS-compliant." Historically, there has been much negativity about NIBRS – that it asks for data while giving nothing in return. The CPD is aware of this and is determined that organizational needs will always have priority over NIBRS requirements.

Key CPD people working on the NIBRS compliance application are in agreement that it is evident NIBRS was developed by statisticians rather than by law enforcement professionals. An illustrative example is that key identifying information such as tattoos are not included in the

NIBRS database. (That and other useful types of information will be stored in the CPD's data warehouse.) One developer opined, "NIBRS does not lead to solving crime." The officers will be trained to collect useful data such as this as part of automated incident reporting rather than because they are NIBRS-related. Optimally they will see the benefits as they begin to use the data warehouse routinely.

Obstacles. Unlike many other jurisdictions, the CPD does not believe funding problems will affect its NIBRS-compliance endeavor. This is due, in part, to having received some federal grant support. But this is the case in greater part because the AIRA application, already under development, is a sophisticated data system with data requirements that exceed those of NIBRS. Analysts found that completing the AIRA mapping document, which ensures that all information entered via AIRA (including NIBRS requirements) will be assigned a data field in CHRIS, was a prodigious undertaking. And the complexity of analyzing relational data looms in the future. For example, a barroom brawl will require the CPD to report on all of the victims and all of the offenders, and to identify at least five relationships among them. This becomes a very complex statistical task that assumes that the responding officer gleaned that information at the time of the incident. Officers were not previously trained to do this, and it will take time for them to get beyond the hierarchy rule (most serious crime) when filling out crime reports. For a time, Chicago will be in the peculiar position of collecting NIBRS data in isolated pockets, because AIRA will be introduced watch by watch, district by district over a still undetermined time period. So while one district may be fully capturing NIBRS data, another district may only do so on two watches, while the remainder of the city still collects data under UCR requirements. And, as mentioned previously, the department intends to collect and use the data for its own purposes, such as an investigative tool, but may not necessarily move to reporting the data because of the public relations implications of the associated perception of increasing crime.

While the CPD does not anticipate the funding woes faced by other agencies, it does share the common concern about how the media will report future NIBRS-compliant crime data. The CLEAR development team is aware that someone will need to educate the media and public about the different reporting methods and the meaning behind the new numbers. The department will handle education of officers internally, but efforts to help the media, legislators and its customers understand NIBRS are still undetermined. A positive outcome the department anticipates under NIBRS compliance is that collecting rich data fields and understanding the various crimes that occur in an "incident" will help them identify crime trends, better understand root problems and, consequently, help with predictive analysis.

The Future of NIBRS Compliance

It appears that Chicago will be ready to collect NIBRS data beginning in early 2003, with the entire city participating as the year progresses. Because Chicago has the second largest police department in the country, the federal government is highly interested in its progress and hopes to use Chicago as a model for other places. The problem, however, is that it is the State's responsibility to report NIBRS data, and few Illinois towns are collecting and reporting NIBRS data. An important issue facing Chicago is that it will be collecting NIBRS data long before the

State of Illinois is ready to report NIBRS data. Time will tell whether the state will have to be reporting on two systems – UCR for towns not participating, and NIBRS for Chicago and the other municipalities that are ready.

Technical Management System

The Technical Management System is a program that was developed by the Data Systems director of development to track CLEAR application development activities, application use and customer relations management (CRM). The Technical Management System was launched in early 2002.

The system's tracking aspect allows management to, at any time, check on project status, recent activity, billable hours and the like. Access to this type of up-to-the-minute information on an ongoing basis has allowed the CLEAR team to find themselves in "firefighting mode" less often, because this management system provides a "big picture" overview.

Application use is tracked by the Technical Management System's auditing capabilities: by means of this program, managers can ascertain exactly who is using particular applications or features of applications, which contributes to system security. Because levels of access are determined by rank and ID, it is possible to know exactly who has used any part of any application. So, for example, if data are "leaked" to a gang or the media, CLEAR's auditing capabilities will allow for identifying every person who had access to that bit of information, which the director of development deems essential in a large organization dealing with sensitive information.

The CRM aspect of the Technical Management System focuses on Web operations. Calls to the Help Desk by CPD personnel (customers) are tracked to determine what type of assistance was given and facilitate followup, if necessary. Help Desk inquiries often point out the need for "bug fixes and enhancements," so analysis of Help Desk activity strives to ensure that nothing "falls through the cracks." In addition, Data Systems personnel can easily recontact the Help Desk "customers" to gain a more thorough explanation of situations requiring a fix, if necessary.

Police Employee Attitudes and Use of Technology

In order to assess the level of knowledge and frequency of use of technology currently available in the CPD, surveys were conducted with personnel in selected police districts. The surveys also probed how computer technology has affected their jobs and their relationships with others in the department. The demographic data that were gathered included rank, education, assignment, time on the job, and whether those working in the district had home computers as well as access to the Internet. Data from these surveys provides baseline information about sworn and civilian personnel's use and attitudes about computers from a point before various CLEAR applications were implemented in their district.

Our research design involved selecting four police districts for study in advance of CLEAR implementation. One district would be the first test site for a variety of CLEAR applications. After sending an introductory letter to the commanders explaining the study, we conducted onsite personal interviews to brief them on our research, gain access to their staff, determine roll call schedules for both patrol and gang and tactical officers, and do a brief facility walkthrough. We would need to return to each stationhouse on three separate occasions to be able to capture data from those on furlough, special assignments and missions, as well as to accommodate the rotation schedule of days off. Between roll calls we moved throughout the stationhouse to hand out surveys to officers and civilians who worked in various offices – supervisors, desk and lockup personnel, and those in the Community Policing unit. Data collection began in March 2002 and was completed in May 2002. Each of the four stationhouses was visited for three 24-hour periods to collect the survey data. At the end of data collection, 759 officers and civilians had completed questionnaires. Research staff briefly stated the purpose of the visit, emphasized the anonymity of the survey – names and star numbers were not taken, so it was not possible to trace responses to specific individuals – and enlisted stationhouse employees’ cooperation before distributing the questionnaires. The survey completion rate varied by district, but stood at 89 to 99 percent. These rates were a reflection of returning to the stations three times, carefully monitoring day-off patterns, and gaining prior cooperation with commanders and watch commanders. Only senior staff members were sent so that their research experience would facilitate data collection efforts and manage the complexities of collecting data in a roll call setting.

Our next report will track trends among personnel serving in the four districts, once CLEAR applications have been implemented. We will examine CLEAR’s impact on sworn and non-sworn jobs as well as ways in which it affects these individuals’ interactions with others in the department.

First Findings

The survey found that many Chicago police officers and civilian personnel are experienced at using computers. They vary in their assessments regarding the impact of information technology on their work. Most think IT has improved their work lives and has changed the way in which the police department does business. In terms of rank, 84 percent held the title of officer, 10 percent sergeant, 2 percent lieutenant, 2 percent civilian and 1 percent captain. The average age of the stationhouse personnel interviewed was 40, and the average age when they came on the job was 28. Eighty percent surveyed were male and 20 percent female, and almost half (47 percent) were working on or had earned a college degree. Thirty-eight percent listed their usual assignment as beat car; 19 percent tactical or gang unit; 15 percent rapid response car; 11 percent office staff, desk, review office or lockup; 6 percent as management, 4 percent in special units such as bike patrol, squadrol, motorcycle or foot patrol; another 4 percent as community policing personnel, and 3 percent as moving between beat and rapid response assignments.

Computers are already widely used in the police department. When asked about their use of a list of existing computer systems, 91 percent indicated that they used at least one system every day. Only 4 percent reported that they used one of the department's systems as little as once or twice a week, or less often than that. Most commonly used were the portable data terminals in patrol cars. Administrative and managerial systems were used most often by district office workers and managers, including the highest-ranked personnel. Crime maps and reports, stolen car databases, and mug-shot files were more often used by officers in the field, most notably by the district's tactical units. Younger and more educated officers also reported more computer use.

One of the strongest factors associated with computer use was training. We asked officers and civilian personnel how they had learned to use the department's systems, and 86 percent reported receiving formal training, most at the police academy, at headquarters or area training sessions, or at their station. Almost 20 percent received some training via computers themselves, using videos that can be accessed from district workstations. Eighty percent said they also had to work on their own, learning how to do things by trial and error, and more than 70 percent got informal help from their fellow workers. Of those who got formal training, 60 percent thought it was adequate, and 40 percent did not. This is important, for the extent and adequacy of formal training was strongly related to every kind of computer use. Well-trained officers and civilian personnel were more likely to appreciate the efficiencies afforded by the new systems; they were more likely to think they made them more effective in their work; and they were more positive about the impact of computing on the police department and on policing as a profession.

Another factor associated with computer use was whether officers and civilian personnel had a computer at home. Just over 80 percent of those surveyed reported having a home computer that could run standard office software, and almost all with home computers reported being connected to the Internet. This is higher than figures for Americans as a whole and suggests that Chicago police are relatively technology-savvy. Across a wide range of measures, officers and civilian personnel with home computing experience were more satisfied users of the department's information technology. Because of the training they received and their frequent use of home computers, it is not surprising that most police officers and civilian personnel feel fairly computer-competent: fully 85 percent rated themselves as very competent or somewhat competent in using computers at work.

There was general satisfaction with the impact of the department's IT on police work. Almost 85 percent of those surveyed reported that computers have increased the accuracy of information available to them, 92 percent thought that they have increased the timeliness of that information, and 95 percent indicated computers have made them more effective. Over 75 percent felt computers made their work more interesting, and 92 percent believed that they make their work easier. In their view, the "paperless office" has yet to appear in the Chicago Police Department – less than one third thought that computing has reduced the amount of paper they use in their work. IT also seems to have affected their accountability. Two-thirds of those surveyed indicated that computers require them to report more frequently about what they are doing, and that they are now more accountable for their actions. Almost 60 percent thought that

computers enable their supervisors to oversee their work more closely, and 80 percent indicated that their supervisors are now more aware of their day-to-day workload. Officers and civilian personnel in these four districts thought that computing has improved management practices in the department (61 percent) and improved information sharing among officers (83 percent). Large majorities felt that computers have improved police service to the public, police response to crime and proactive policing.

As noted above, this survey was conducted to provide a baseline for assessing future improvements in the department's information systems. Another round of surveys will examine changes in the use of specific information systems and acceptance of new systems as they come online. The data will contribute to our overall assessment of the impact of modern information technology on policing in Chicago.

Future CLEAR Applications

Several CLEAR applications remain in the conceptual stage and may come under development during the next year. These applications are described below:

Automated Pawnshop. This application, as planned, would develop a mechanism for pawnshops to provide online inventory reports, which would then be cross-checked against case reports and Evidence and Recovered Property Section (ERPS) inventories.

Enhanced Hot Desk. This module will make accessing Hot Desk information (open warrants, stolen cars, etc.) faster and easier for the CPD. Currently, officers have to use a dial-up connection to get into the Illinois State Police mainframe; the enhanced module will be Web-based.

Probation and Parole. This application will provide a data feed between the Illinois Department of Corrections (IDOC) and the CPD, providing information on releases as well as on conditions of probations and paroles. To date, proposals have been submitted for grant funding, and the Oracle agreement has been amended to include this.

Community/Business Partnership. Increasing public interest in police effectiveness in problem solving, and concern about police accountability and potential misconduct, calls for greater public input in the measurement of police performance. The department plans to develop new community-based measures of police performance that reach beyond traditional performance measures to capture information about a broad range of community concerns. The goals for this application include strengthening problem-solving capacity, conducting community-needs assessment, creating a convenient information-sharing mechanism and receiving intelligence information from the community. The system could collect ongoing, systematic data on quality-of-life indicators, citizen participation levels, police performance on various dimensions and the overall strength of police-community relations.

Community Interest and Readiness for Involvement

As part of the CLEAR evaluation, an ongoing University of Illinois at Chicago study is addressing the community's readiness to participate in a partnership with the Chicago Police Department built around Web-based communication.

Community/Business Partnership Research

The Chicago Police Department proposed the Community/Business Partnership as a component of the CLEAR initiative in order to 1) enhance problem-solving capacity, 2) improve community needs assessment, 3) make information sharing easier and more convenient, and 4) gather more intelligence through community sources. The creation of a sophisticated Web-based system for communicating with the public also has the potential to help the CPD achieve several management objectives under CLEAR, especially in the areas of accountability and strategic planning. Strategic management in the 21st century covers a broad range of proactive functions, including crime control, order maintenance, fear reduction, public satisfaction and accountability. In theory, the systematic collection, analysis, utilization and dissemination of new community-based data, reported via the Internet, holds the promise of empowering both police officers and local residents involved in the process of proactive problem solving and community crime prevention.

At present, the Community/Business Partnership application is in the conceptual stage. The department expressed a commitment to move ahead with the planning of the Community/Business application, and the joint evaluation team at Northwestern University and the University of Illinois at Chicago (UIC) agreed to provide the CPD with research assistance. The research team is engaged in several tasks. First, we are assisting in the conceptualization and development phase by identifying key information components for Web-based community modules. Second, we are engaged in a formative assessment of this component by exploring community interest and readiness for Internet communication with the CPD. This includes gathering information about residents' access to the Internet, usage of the current CPD Web page and reactions to a preliminary Web-based survey. Third, we are proposing a "demonstration and evaluation" plan for field-testing this new initiative. Each of these research activities and corresponding results is discussed below.

The research team has made significant progress on a plan for expanding the Internet link between the CPD and Chicago communities. Regular meetings have been held with CPD representatives, UIC and Northwestern University faculty and PhD students. As a byproduct of this dialogue, a steering committee was created to continue this process and to develop an overall plan for this application. To assist in this process, UIC has prepared a concept paper for the CPD. This concept paper describes the value of a comprehensive CPD Web page that would include at least five key components:

Problem reporting. This component would afford Chicago residents the opportunity to formally report crime and disorder incidents to the CPD over the Internet. Citizens participating in monitoring could be invited to:

- Submit and obtain traffic crash reports
- Make initial reports of minor criminal activity
- Report persistent disorder problems
- Report suspicious activity

Citizen monitoring. Through Web-based surveys, this unique feature could provide the CPD with a mechanism to enhance the police-community partnership initiated with CAPS and to institutionalize past efforts to “measure what matters” in 21st century policing. Citizen reporting could supplement Citizen ICAM, beat meetings and district advisory committees as a method for collecting information about a wide variety of issues that are of concern to both the police and community. The Citizen Monitoring program, using random samples of citizens selected to monitor and report conditions in their police beat on a monthly basis, could be designed to achieve the following objectives:

- Assess neighborhood conditions
- Assess citizen performance in community activities
- Assess police performance on a range of dimensions
- Evaluate anti-crime interventions
- Offer recommendations

An open question is the auspices for conducting a monitoring program. An independent monitoring component could enhance the credibility of the process and encourage citizen participation.

Neighborhood profile report. To further the dialogue between police and residents the CPD could provide analysis and feedback based on the information that they accumulate from all sources, creating a two-way flow of information between the parties. The Citizen ICAM component of the city’s Web site is one step in this direction. A Neighborhood Profile Report could provide the community with:

- Crime information on incidents and arrests with geographic location (e.g. ICAM)
- Citizen monitoring results such as neighborhood and beat profiles, performance indicators and community survey results

CAPS Online. This feature, designed specifically to enhance community policing in Chicago and to facilitate direct communication between police and community members, could have several features:

- Provide CAPS information such as meeting times, locations, agendas and guest speakers

- Host listservs and message boards
- Provide an automated problem-solving module for Problem Oriented Policing (POP) projects (including a training tutorial to strengthen the integrity of the CPD's five-step problem-solving model).

Public service links. This component would allow the CPD to link residents to other public safety services online and assist them in finding help with other problems. Links would include sites with information about social, educational, health, employment, legal and public safety services to help build individual and community competencies.

Current Citizen Access to the Internet and the CPD

As part of this formative assessment the research team has focused on two primary tasks. First, we sought to gauge the capacity and interest of community residents to engage in Internet communication with the CPD. Second, we focused our attention on the feasibility of implementing a Web survey that would serve as the Citizen Monitoring component outlined earlier. Each of these activities is described below.

Access to the Internet. To assess community readiness for Internet communication, questions about Internet access were included in the survey of residents attending beat meetings. (A detailed description of the study was presented in the resident involvement section of this report.) The findings provide a profile of the Internet-readiness and interest of CAPS meeting attendees – a group that is likely to be among the first in line to use any future Web-based system. The results provide estimates of levels of access and usage of this technology, as well as identify populations in need of special outreach.

The beat community meeting survey included the following three questions regarding IT:

- Do you have a personal computer at home?
- If yes, do you use it to connect to the Internet or to check e-mail?
- Have you ever used the Chicago Police Web site or online ICAM crime mapping?

The results of these questions probably underestimate the extent of Internet access by Chicagoans, because they do not reflect access through computers at work, or through those in public facilities such as libraries and schools.

Of the 3,455 residents who answered these questions, 68 percent indicated they had a home computer; 80 percent of those owning a computer indicated that they were connected to the Internet; but only 35 percent of those with Internet access indicated that they had either visited the CPD Web site or online ICAM.

To better understand the project's potential audiences – those with a home computer and already using the Internet – we constructed a demographic profile of computer users. The strongest predictors of computer ownership, Internet use and visiting the police Web sites are age and education. Computer use declines with age and increases with education. Among beat

community meeting participants, 85 percent of those under age 40 own a computer, compared to 41 percent of those over age 65. Furthermore, the greater majority (89 percent) of computer-owning residents younger than 40 years old have Internet access, while 66 percent of computer owners older than 65 use the Internet. Connecting to the CPD Web site or ICAM followed the same trend, with 44 percent of those under 40 having visited these sites, and only 16 percent of those over 65 having done so.

Computer ownership and use varies even more widely by education. Only 36 percent of those not graduating from high school reported owning a computer, while 87 percent of those with college degrees reported having a computer. These trends also hold for having an Internet connection and visiting police Web sites. Home ownership is correlated with owning a computer; having a PC was reported by 71 percent of home owners and 58 percent of renters. (We note that 58 percent represents a relatively high level of computer ownership among renters, however.) Among computer-owning renters and home owners, Internet usage figures are quite similar (75 percent vs 81 percent), as are figures for those visiting the CPD Web sites, (36 percent vs 34 percent). Responses to these three questions did not differ significantly by gender, though percentages for males are slightly higher than those for females.

Perhaps the most interesting finding was that race was only a modest predictor of computer ownership and use. Seventy percent of white and Latino beat-meeting attendees reported owning a computer, as did 65 percent of African-Americans attendees. Of those who reported owning a computer, 88 percent of whites, 77 percent of Latinos and 73 percent of African-Americans reported Internet use. But among these Internet users, only 42 percent of whites, 34 percent of Latinos and 28 percent of African-Americans have visited CPD Web sites.

Figure 29 demonstrates the magnitude of all of these differences in computer access. It is based on all of our respondents, so in each case the bars are cumulative. For example, about 41 percent of those age 65 and older who attended beat meetings during 2002 had a home computer. Sixty-six percent of them reported having internet access, or 26 percent of all senior citizens who were surveyed. Few of them had accessed the CPD Web site, so in the end only 6.5 percent of all of those over age 65 had done so. Save for those without a high school education – whose responses are also presented in Figure 29 – they were the least computer-savvy group. College graduates and those under age 40 were the most “wired,” with CPD access percentages approaching 40 percent.

These findings indicate that there is an opportunity to enhance resident-police partnerships through IT by increasing public awareness of sites currently available, as well as by upgrading existing Web sites to enable interactive communication between residents and the police who serve them. At present, CPD Web sites provide only one-way communication – the department has harnessed communication technology to disseminate its message to the public.

Figure 29
Race, Age, Education and Patterns of Internet Access

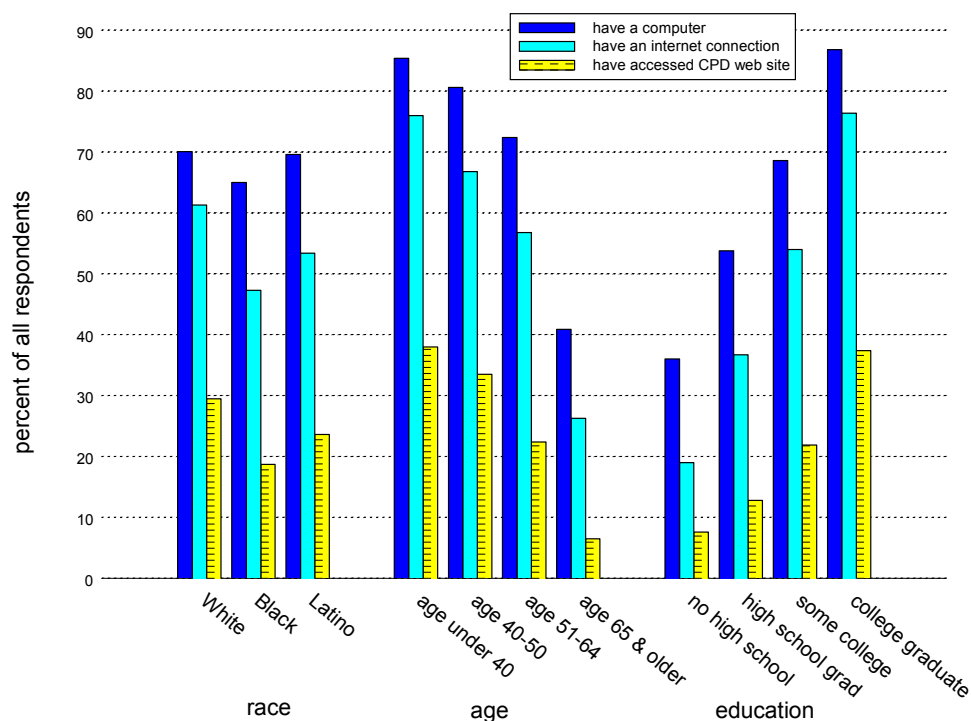

But while residents are well-positioned to do so, they have no reciprocal opportunity to provide input and feedback about crime, neighborhood conditions and the officers who serve their neighborhoods. A two-way Web-enabled communication would not only strengthen the Chicago Police Department's partnership with its constituents, but it would also enrich the department's accountability pursuits.

Feasibility Study of a Web-based Survey

Our second major task as part of the formative assessment was to develop and test the feasibility of a Web-based survey that would provide the foundation for an expanded system of Internet communication between the CPD and the public. This task was the primary responsibility of UIC members of the research team. They focused on a component of the system with which they have extensive experience and one for which the greatest benefits are likely to accrue: Web-based surveys of community residents. The plan was to develop and test a prototype Web-based survey that would capture the essence of the Citizen Monitoring component outlined above, including collecting data on a wide variety of neighborhood conditions; residents' perceptions and fears about crime and safety; police-community relations; and other issues that are important in community policing.

The prototype survey included questions drawn from the CAPS evaluation surveys described earlier in this report. They were included in the draft Web survey because of their content validity and demonstrated reliability. Later research will enable us to compare responses generated by Web- and telephone-based surveys for validation purposes. Our Webmaster prepared a site that includes the Web survey.

The next step was to gather input and feedback from a diverse set of Chicago residents about the content of the survey and the feasibility of Web-based communication between the CPD and local residents. To obtain this feedback, three focus groups were convened during November 2002. Police beats were identified using the evaluation's survey data on where attendance rates and access to personal computers and the Internet is relatively high. Beats were selected to represent predominately African-American, Latino and white communities. The UIC team attended meetings in these areas and invited citizens with Internet access to remain afterward for a focus group meeting. The principal UIC investigator served as facilitator each time and two graduate students recorded the dialogue. The participants were asked to visit the prototype Web site and complete the Web survey, which included an open-ended question through which respondents could give us feedback about the user-friendliness of the survey and the content of the questions.

Focus group questions. To confirm the content validity of our Web survey and to consider new measures, focus group participants were asked the following four questions:

When you think of the police and the community having a "good" relationship, what comes to mind? How would you define it?

When you think of the police and the community having a "bad" relationship, what comes to mind? How would you define it?

When you think of making your neighborhood safe, what do you think the police should be doing? [Probe: What is doing a "good job" on the part of the police?]

When you think of making your neighborhood safe, what do you think its citizens should be doing? [Probe: What is doing a "good job" on the part of the citizens?]

To explore the feasibility of Web-based communication with the police, focus group participants were then asked the following three questions:

If you could report crime or suspicious activity online through a home computer, would you be willing to do it? What types of crime or circumstances would you be willing to report over the Internet? (Probe why.)

What do you see as the major benefits and drawbacks of communicating with the police department over the Internet? (Probe opinions about surveys of neighborhood conditions and of police performance).

What types of information would you like to receive from the Chicago Police Department?

An examination of the discussion at the three focus group meetings revealed some common themes and concerns.

What to measure. Two basic concepts emerged when citizens were asked to characterize “good” and “bad” police-community relations – partnership and performance.

- *Partnership.* This concept was described as “teamwork” and characterized by communication, “information sharing,” interaction, and trust between officers and citizens. Participants tended to place the onus of “building relationships” on the police rather than on citizens.
- *Police Performance.* This was generally expressed through the concept of police response to community concerns and crime problems. Most characterized a bad police-community relationship by their perception of police “not responding to our needs,” typically exemplified in either officers not responding to concerns that citizens brought to their attention or police “not prioritizing,” but rather focusing efforts on problems citizens did not feel were important.

When asked to characterize the role of both police and citizens in “making your neighborhood safe,” two basic ideas emerged – proactive patrolling for police and increased participation for citizens.

- *Proactive Patrol.* The general perception was that police maintain or improve neighborhood safety through patrolling that is both highly visible and proactive. Visibility entailed officers engaging in foot patrol instead of “hiding in a car” and generally making their “presence known” in the community. Proactive patrol included officers “working in conjunction with neighbors,” addressing chronic problems, and being “more observant” about potential crime situations and signs of neighborhood physical disorder that require police attention.
- *Increased Participation.* Respondents felt that citizens contributed to neighborhood safety by increasing their participation within the community. Participation was typically characterized as starting “block clubs,” interaction with neighbors, watching for suspicious activity, attending CAPS meeting and sharing information with both police and neighbors.

Feasibility of online reporting. The feasibility of online problem reporting received mixed reviews from the focus group participants. Some envisioned great benefits, while others expressed concern. Primary themes and their implications were as follows:

- *Response Time.* Several participants doubted that police response to crimes reported through the Internet would be handled in “real time” or quickly enough for the Internet to be a viable forum for reporting emergencies.
- *Privacy.* Several participants were concerned by the “tracing factor” associated with communication through the Internet and whether their identities could be protected to facilitate sharing sensitive information with the police in this forum.

- *Digital Divide.* Those without Internet access would not be able to avail themselves of this forum for reporting, especially those who need the additional forum most: members of high-crime, low-income neighborhoods.
- *Isolation.* Some participants believed that reporting to a computer, as opposed to talking to police personnel, “takes away the personal effect,” leading to “detachment” of the individual from the community, as well as from the police. However, others also expressed interest in the concept of the Internet as a tool to organize and strengthen community responses to crime (for example, listserv for sharing information about Neighborhood Watch and CAPS beat community meetings.)

Feasibility of Web surveys. We also explored the feasibility of Web-based opinion surveys. The concept of Web-based surveys was not familiar to many respondents, and we did not have adequate time to explain our thinking in detail. Participants were introduced to the idea that some residents might be randomly selected to participate in a series of surveys and function as “neighborhood monitors.” This stimulated some discussion around two themes with implications for future development:

- If monitors are “designated people” in the neighborhood, these individuals would require anonymity to avoid undue pressure from both police and fellow citizens. These monitors would have to be carefully selected if they are to be representative of their neighborhoods and should be responsible for reporting on conditions and performance in relatively small geographic areas.
- The collection of survey data might overwhelm a police department lacking the resources, skills or willingness to analyze these community assessments or address the needs identified in the survey. This raises important questions about who should manage the dataset and how best to foster accountability to the public. Furthermore, mechanisms for sharing the survey results with the community should be in place.

Desirable information. Finally, the types of information that participants want to receive from the Chicago Police Department pertain to the following:

- budget
- statistics (arrests, resources) broken down geographically and by race
- crime trends
- outcome of reported or known incidents
- beat logs

Web Survey Test Results

To date, the Web survey has been completed online by eight residents who participated in the three focus groups. Overall, the results are very encouraging. Respondents were able to

complete all sections, which covered the quality of neighborhood social life (including social cohesion, fear and collective efficacy); the severity of neighborhood crime and disorder problems; the level and types of citizen involvement in public safety; assessments of police activity levels and performance; and the demographic characteristics of respondents.

Respondents were encouraged to comment on the quality and content of the Web survey upon completion. These open-ended responses were quite positive and constructive. One noted, "Everything is well-explained and there are no confusions or complications in this survey." Another said, "I think the survey covered a lot." In terms of constructive suggestions, one respondent asked us to explore reasons why some citizens might report feeling safe in their neighborhood (we included questions about why they might feel unsafe). Another asked us to further clarify our question about whether they have attended community meetings to indicate specifically whether it included CAPS beat community meetings.

Focus Group Findings

We were encouraged by this preliminary feasibility study. First, many dimensions deemed important to local residents had already been considered for inclusion in the survey, including proactive patrol, police visibility and citizen participation. These findings, however, are a reminder to police researchers not to forget the importance of two classic measures of police activity from the public's viewpoint – response time to the public and patrol visibility.

In terms of online reporting, residents are cautious, but optimistic. Concerns about response time are real and, therefore, serious in-progress incidents are not good candidates for Web reporting. Concerns about privacy and security cuts both ways. As one participant noted, "If we can have protection, it would be pretty good." If the proper precautions are taken to safeguard anonymity, residents see considerable benefit to online reporting of criminal activity such as narcotic trafficking and gang activity in the neighborhood without fear of exposure.

Whether online reporting serves to strengthen, weaken, or have no effect on police-community relations remains an empirical question. Concerns about social isolation can be addressed by supplementing online reporting with personal contact. In any event, the CPD will need an initial automatic response program that notifies the individual that his/her report has been received and assigned a reference number, and, if the user so desires, offers a timely and personal response through email or telephone by an officer.

A final cautionary note: While these findings are interesting, we emphasize that three focus groups are not representative of any particular community or the city as a whole. The consistency of responses across three racial/ethnic groups gives us some confidence in the general pattern of feelings. However, at best, these results apply to residents who have access to the Internet and attend CAPS beat meetings.

Future plans for the Community/Business Partnership application could make use of these findings and should, in turn, be subjected to careful evaluation. We have recommended that the CPD implement a “Demonstration and Evaluation” model, where researchers and practitioners work together to implement a carefully controlled study as part of a prototype demonstration program.

CLEAR in the Coming Year

This first report on CLEAR presented a descriptive summary of progress made on the many applications being developed and implemented at the Chicago Police Department. The CPD has overcome many of the obstacles to implementing information technology that have been identified in earlier studies. The department has secured considerable funding for CLEAR and has a highly dedicated and talented team of staffers from within the department and from Oracle Corporation devoted to the project. CLEAR’s architects have a solid understanding of IT and have engaged in several processes to ensure good product outcomes. They have kept at the forefront the importance of officer acceptance. They have done so through customized training, comprehensive testing and pilot-testing, and inclusion of stakeholders in development and implementation of the various applications. When CLEAR is fully launched, the Chicago Police Department will be the only department of its size to have an automated incident reporting system in place.

Some of the impediments that remain include securing the continued flow of funding, station infrastructure challenges and the continuing balancing act of time management. Each application requires tremendous time and effort, and many applications are dependent on one another for full implementation. A continuing issue is the protection and privacy of the data to be manipulated and shared. While data sharing holds tremendous promise in terms of problem solving, predictive analysis and cost-effectiveness, it also holds the ongoing threat of revealing data inappropriately or violating Chicagoans’ civil rights. The protection of individual privacy will be an ongoing issue in all IT projects. Another hurdle will be how the department will involve the community and local business in a meaningful and mutually beneficial partnership. A true partnership will be forged when the community is not regarded merely as a source for providing crime information to the police, but when it is considered a resource for feedback on neighborhood conditions and the officers who serve them. Community input should be an important part of the accountability equation.

CLEAR’s ultimate goals address reducing crime as well as increasing accountability and efficiency by means of using information in new and creative ways. However, it is too early to judge the system’s effectiveness in meeting these goals, for many of its applications are in the embryonic stage. If the many applications with upcoming completion dates reach fruition, our second report should be able to begin assessing these efforts.

We emphasize that much planning and research lies ahead before Chicago will have a good sense of how Web-based communication might affect police officers, community residents and the CPD. At this point, residents are being asked to respond only to a concept and a limited

field test; results are mixed on the former and encouraging on the latter. The only way we will know for certain is to develop the programs, deliver them, and assess their impact on the community and the police through controlled research. The relationship between virtual and physical communities remains an unexplored empirical question in the criminal justice field.

Citations

Chan, Janet B. L. (2001). "The Technology Game: How Information Technology is Transforming Police Practice.: *Criminal Justice*, 1 (2): 139-159.

Coldren, J. David (1996). "Changes at the Speed of Light: Doing Justice in the Information Age." In Richard Scherpenzeel (ed.). *Computerization in the management of the criminal justice system*. Proceedings of the Workshop and the Symposium on the Computerization of Criminal Justice Information at the Ninth United Nations Congress on the Prevention of Crime and the Treatment of Offenders. HEUNI Publication series no. 30, Helsinki/The Hague: European Institute for Crime Prevention and Control.

Coldren, James, et al. (2000). "National Assessment of the Strategic Approaches to Community Safety Initiative: Cross-Site Themes in the Process Evaluation." Paper presented at the annual meeting of the American Society of Criminology, San Francisco, November, 2000.

Dunworth, Terence (2000). "Criminal Justice and the IT Revolution." In Julie Horney, John Martin, Doris L. MacKenzie, Ruth Peterson & Dennis Rosenbaum (eds.). *Policies, processes, and decisions of the criminal justice system*. Vol. 3, pp. 371-426, Criminal Justice 2000 series. Washington, DC: U.S. Department of Justice, National Institute of Justice.

Lavrakas, Paul, J., Rosenbaum, Dennis, P., & Kaminski, Frank. (1983). "Transmitting Information about Crime and Crime Prevention to Citizens: The Evanston Newsletter Quasi-Experiment." *Journal of Police Science and Administration*, 2: 463-473.

McDonald, Phyllis (2000). "COP, COMPSTAT, and the New Professionalism: Mutual Support or Counter Productivity?" In Geoffrey P. Alpert & Alex R. Piquero (eds.). *Community Policing: Contemporary Readings*, 2nd edition, pp. 233-255.

Ramsey, Charles H. (2000) "Preparing the Community for Community Policing: The Next Step in Advancing Community Policing." In Dennis J. Stevens (ed.). *Policing and community partnerships*. pp. 29-44, Upper Saddle River, NJ: Prentice Hall.

Reuland, M. M. (1997). Information management and crime analysis: *Practitioner's recipes for success*. Washington, DC: Police Executive Research Forum.

Project Papers
Chicago Community Policing Evaluation Consortium

1. The Public and the Police in The City of Chicago, by Tabatha R. Johnson (August 1993).
2. Winning the Hearts and Minds of Police Officers: An Assessment of Staff Perceptions of Community Policing in Chicago, by Arthur J. Lurigio and Wesley G. Skogan (July 1994).
3. Partnerships for Prevention? Some Obstacles to Police-Community Cooperation, by Wesley G. Skogan (July 1994).
4. Community Participation and Community Policing, by Wesley G. Skogan (October 1994; revised January 1995).
5. Spring 1994 Supervisor Training Evaluation Report, by Arthur J. Lurigio, Sheila Houmes and Sigurlina Davidsdottir (March 1995).
6. Preparing Police Officers for Community Policing: An Evaluation of Training for Chicago's Alternative Policing Strategy, by Gail Dantzker, Arthur J. Lurigio, Susan M. Hartnett, Sigurlina Davidsdottir, Kristin Donovan, and Sheila Houmes (April 1995).
7. Resident Survey Methods Report, by Wesley G. Skogan (March 1995).
8. An Analysis of Beat Meeting Participation and Activity, by Scott Althaus (June 1995).
9. District Advisory Committees: The Prototype Experience, by Jill DuBois (April 1995).
10. Problem Solving Case Studies, by Dominique Whelan (February 1995).
11. Community Organization Survey Methods Report, by Justine H. Lovig and Robert VanStedum (April 1995).
12. Community Organization Study, by Justine H. Lovig and Wesley G. Skogan (February 1995).
13. 1995 CAPS Training Evaluation Report, by Marianne Kaiser (June 1995).
14. 1995 Joint Community-Police Training: Interim Report, by Marianne Kaiser (February 1996).
15. Community Mobilization Around CAPS, by Susan F. Bennett. (December 1996).
16. 1996 Beat Meeting and Citizen Training Participant Study, by Justine Lovig, Jinney Smith and Wesley G. Skogan (October 1996).
17. Evaluating Problem-Solving Policing: The Chicago Experience, by Wesley G. Skogan (December 1996).
18. Measuring What Matters: Crime, Disorder and Fear, by Wesley G. Skogan (February 1997).
19. Super Block Project, by Raj C. Udeshi (May 1998).
20. Institute for Public Safety Partnerships: A First Year Evaluation, by Jennifer Comey and Marianne Kaiser (July 1998).
21. 1998 Citywide Beat Meeting Observation Methodology Report, by Joel F. Knutson and Wesley G. Skogan (June 1999).
22. CAPS Evaluation Officer Surveys Data Documentation, by Wesley G. Skogan (April 2000).
23. CAPS Citywide Resident Survey Documentation, by Wesley G. Skogan (April 2000).
24. Community Mobilization for Community Policing by J. Erik Gudell and Wesley G. Skogan (pending).
25. The 2002 Problem Solving Study by Jason Bennis, Lynn Steiner and Wesley G. Skogan (January 2003).
26. The 2002 Beat Meeting Observation Study by Jason Bennis, Wesley G. Skogan and Lynn Steiner (January 2003).
27. Statistical Analyses of Timeseries Data on Problem Solving by Wesley G. Skogan and So Young Kim (January 2003).

All project papers are available on the web at www.northwestern.edu/IPR/publications/policing.html.

Books on Community Policing in Chicago

Community Policing, Chicago Style. By Wesley G. Skogan and Susan M. Hartnett. Published by Oxford University Press, \$29.95.

On the Beat: Police and Community Problem Solving in Chicago. By Wesley Skogan, Susan M. Hartnett, Jill DuBois, Jennifer T. Comey, Marianne Kaiser and Justine H. Lovig. Published by Westview Press, \$65.00.